

Canon

Basic Operation Guide

imageCLASS

D 5 6 0 / D 5 3 0

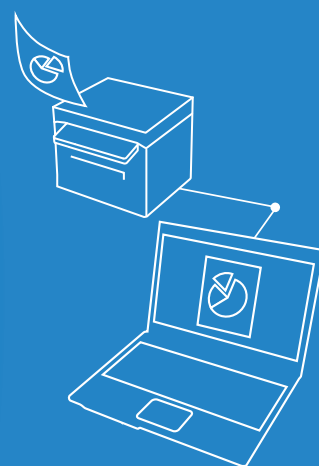
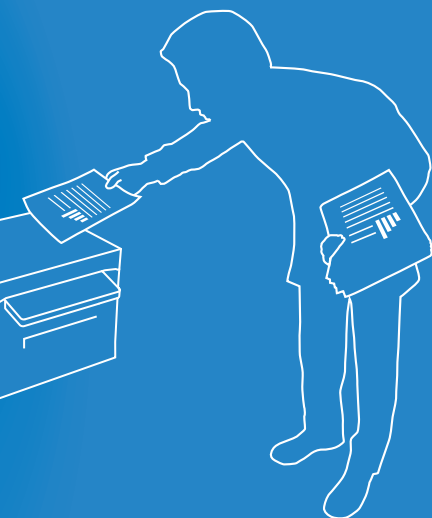

For information about machine setup and software installation, see the Starter Guide.

- This guide describes the basic use of the machine. Read this guide after finishing the machine setup.
- Read "Important Safety Instructions" first (→p.72).
- Keep this manual for future reference.

For information about advanced operations and specifications, see the e-Manual included on the User Software CD-ROM.



Manuals for the Machine



Starter Guide

The Starter Guide describes setting up the machine and installing the software. Be sure to read this manual before using the machine.



Basic Operation Guide

The Basic Operation Guide describes common use and basic functions of the copy and print functions.



e-Manual

The e-Manual includes information about all functions and configurations of the machine. This manual is included on the User Software CD-ROM. Use the e-Manual's search function to easily find the information you want.

For Macintosh Users

The examples shown in this manual are based on the operation in the Windows environment. To view how to use printer driver and scanner driver, refer to the driver guides included in the User Software CD-ROM and the driver's help.



Displaying Driver Guides

To view the Driver Guides, double-click the HTML files from the following folders on the User Software CD-ROM.

- Canon MF Printer Driver Installation Guide ➔ [Documents] ➔ [Print] ➔ [Guide] ➔ [index.html]
- Canon Scanner Driver Guide ➔ [Documents] ➔ [Scan] ➔ [Guide] ➔ [index.html]

Displaying from Driver's Help System

From each driver panel, click [?]

How to Use This Manual

Symbols Used in This Manual



Indicates a situation that may lead to death or injury to persons. To use the machine safely, always pay attention to these warnings.



Indicates a situation that may lead to injury to persons or damage to equipment. To use the machine safely, always pay attention to these cautions.



Indicates an operation that must not be performed. Read these items carefully, and make sure not to perform the described operations.



Indicates operational requirements and restrictions. Be sure to read these items carefully to operate the machine correctly and avoid damage to the machine or property.



Indicates a clarification of an operation or additional explanations for a procedure. Reading these notes is highly recommended.

Keys and Buttons Used in This Manual

In this manual, the following styles are used to represent keys, messages on the display, and buttons or other items on a computer screen.

- Operation panel keys: [Key icon] (Key name)
Example: [] (Stop)
- Display: <Message>
Example: <Specify Destination>
- Buttons and items on a computer screen: [Item]
Example: [Preference]

Illustrations Used in This Manual

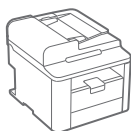

Illustrations Used in This Manual

Illustrations of the D560 are used in this manual. If a procedure or topic applies to only one machine, this will be clearly indicated in the manual (for example, "D530").

Displays Used in This Manual

The display shown in this manual is the factory preset display for the D560. Depending on the system configuration and product purchased, the appearance of the display may differ.

Main Functions

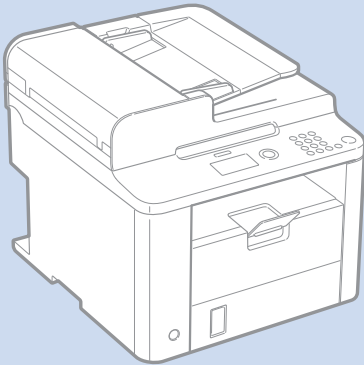

Scan



Scanning using the Operation Panel → P.45

Select a computer to save scanned images in and scan images directly from the operation panel.

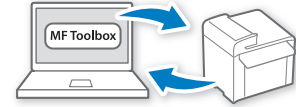

Remote Scanning from Computers → P.46

Set to use the remote scan from the machine, and then scan images from a computer using the MF Toolbox.

Copy



Collating Copies → P.32

Collate copies when copying multiple documents.



Copying ID Card → P.33

Copy both sides of an ID card onto a single page.



Adjusting Quality → P.29

Adjust image quality by setting the density, resolution, and sharpness.



Enlarging and Reducing → P.29



Multiple Documents onto Single Page → P.32

Print multiple pages onto a single page.



2-Sided Copying → P.31

Print copies or documents on both sides of paper.

Print



Booklet Printing → P.39

- Combine two pages onto a single page, and then print on both sides.
- Make a booklet by folding printouts in half and binding.



Poster Printing → P.40

- Magnify and divide a single-paged image to print on multiple sheets of paper.
- Make a poster by combining the prints together.



Watermark Printing → P.41

Add watermarks, such as "COPY" or "DRAFT", to the document.



Enlarging and Reducing → P.36



Multiple Documents onto Single Page → P.38

Print multiple pages onto a single page.



2-Sided Printing → P.37

Print copies or documents on both sides of paper.

Contents

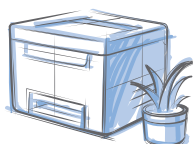

Basic Operation

Learn the Names and Functions of Each Part of the Machine	8
Front Side	8
Interior	10
Back Side	11
Learn the Functions of the Operation Panel	12
Switch to Copy or Scan Mode.....	13
Enter Text	14
Set Date and Time	15
Place Documents	16
Placing Documents on the Platen Glass	17
Placing Documents in the Feeder (D560 Only)	17
Load Paper	19
Loading Paper in the Paper Cassette	20
Loading Paper in the Multi-Purpose Tray	21
Loading Envelopes or Paper with a Letterhead	22
Setting a Paper Size and Type	23
Switch to the Quiet Mode	24
Switch to the Sleep Mode	24
Use the Toner Saver Mode	25



Copy

Make a Basic Copy	28
Enlarge or Reduce Copies	29
Adjust the Image Quality for Copy	29
Adjusting the density	29
Selecting the Document Type	30
Adjusting the sharpness	30
Make Double-Sided Copies	31
Copy Multiple Pages onto One Sheet	32
Collate Copies	32
Copy a Double-Sided ID Card.....	33
View and Cancel Copy Jobs	34
Change the Default Copy Settings	34

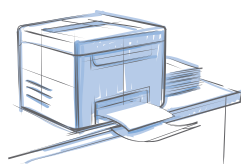

Print

Print a Document	36
Enlarge or Reduce a Document	36
Print a Double-Sided Document	37
Print Multiple Pages onto One Sheet	38
Print a Booklet.....	39
Print a Poster	40
Add Watermarks to a Printout	41
View and Cancel Print Jobs.....	42



(→ p.69)

You can see frequently asked questions about the scan function.

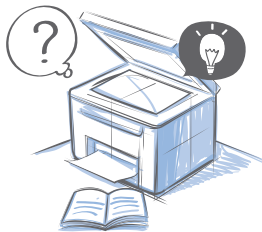
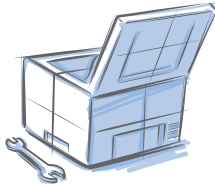

Scan

Understand the Scanning Method.....	44
Scan a Document with the Operation Panel	45
Scan a Document with the MF Toolbox.....	46
Configuring Scan Settings Using the MF Toolbox	48
Scan a Document with the Scanner Driver	50

Maintenance and Management

Clean the Machine	52
Cleaning the Exterior and Interior	52
Cleaning the Fixing Unit	53
Cleaning the Platen Glass and Feeder	54
Check and Replace Toner Cartridges	55
Conserving the Toner to Extend the Life of Toner Cartridges.....	55
Replacing the Toner Cartridge	56
Manage Using the List Function.....	58

Troubleshooting

Clear Jams	60
Clearing Document Jams in the Feeder (D560 Only)	61
Clearing Paper Jams Inside the Machine	62
Resolve a Displayed Message.....	65
Resolve an Error Code.....	65
Improve Output Quality	66
Resolve a Problem	68
FAQ	69

Recycling Used Cartridges	71
The Clean Earth Campaign.....	71
Important Safety Instructions	72
Legal Notices	74
Laser Safety.....	74

Basic Operation

This chapter describes overall information about the machine, and how to place the documents and load the paper. Read this chapter first.

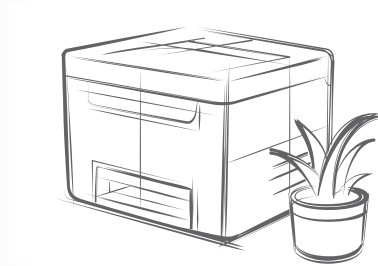

Learn the Names and Functions of Each Part of the Machine	8
Front Side	8
Interior	10
Back Side	11
Learn the Functions of the Operation Panel	12
Switch to Copy or Scan Mode	13
Enter Text	14
Set Date and Time	15
Place Documents	16
Placing Documents on the Platen Glass	17
Placing Documents in the Feeder (D560 Only)	17
Load Paper	19
Loading Paper in the Paper Cassette	20
Loading Paper in the Multi-Purpose Tray	21
Loading Envelopes or Paper with a Letterhead	22
Setting a Paper Size and Type	23
Switch to the Quiet Mode	24
Switch to the Sleep Mode	24
Use the Toner Saver Mode	25

Learn the Names and Functions of Each Part of the Machine

Front Side

D560

D530

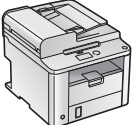

Feeder (D560 only)

Automatically feeds documents into the machine (→P.17).

Document feeder tray

Place your documents in this tray.

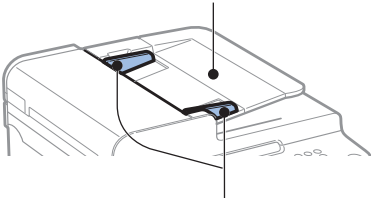

Document guides

Adjust these guides to fit the document.

Feeder cover (D560 only)

Open this cover to clear paper jams (→P.17).

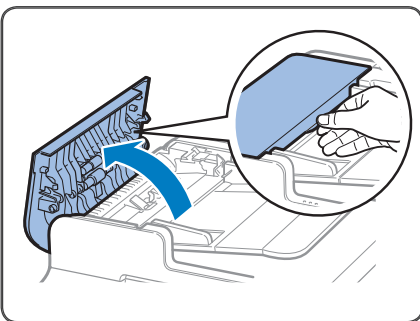

Lift handles (left, right)

Hold these handles to lift or transport the machine.

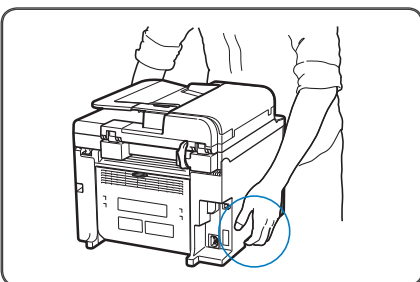

Operation panel

Use the panel to control the machine (→P.12).

Document return tray

(D560 only)

Returns documents after scanning.

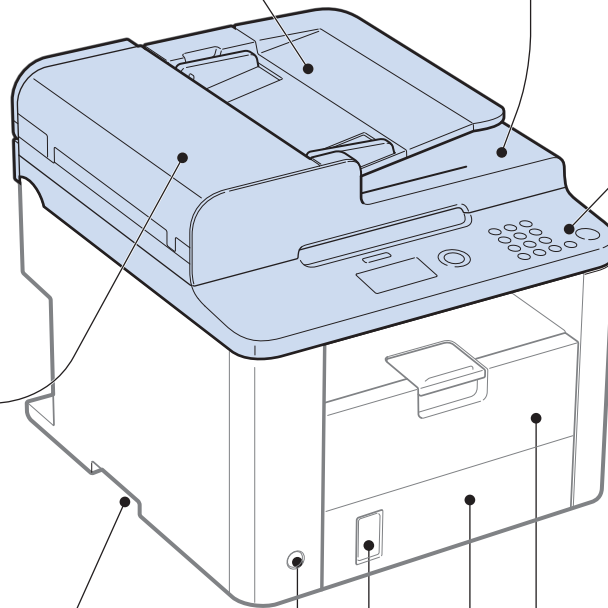

Front cover

Open the cover to load paper.

Power button

Turn the power ON or OFF.

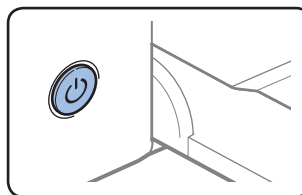

Lower front cover

Open when using paper that is larger than LTR size.

Paper level indicator

Shows the remaining amount of paper.

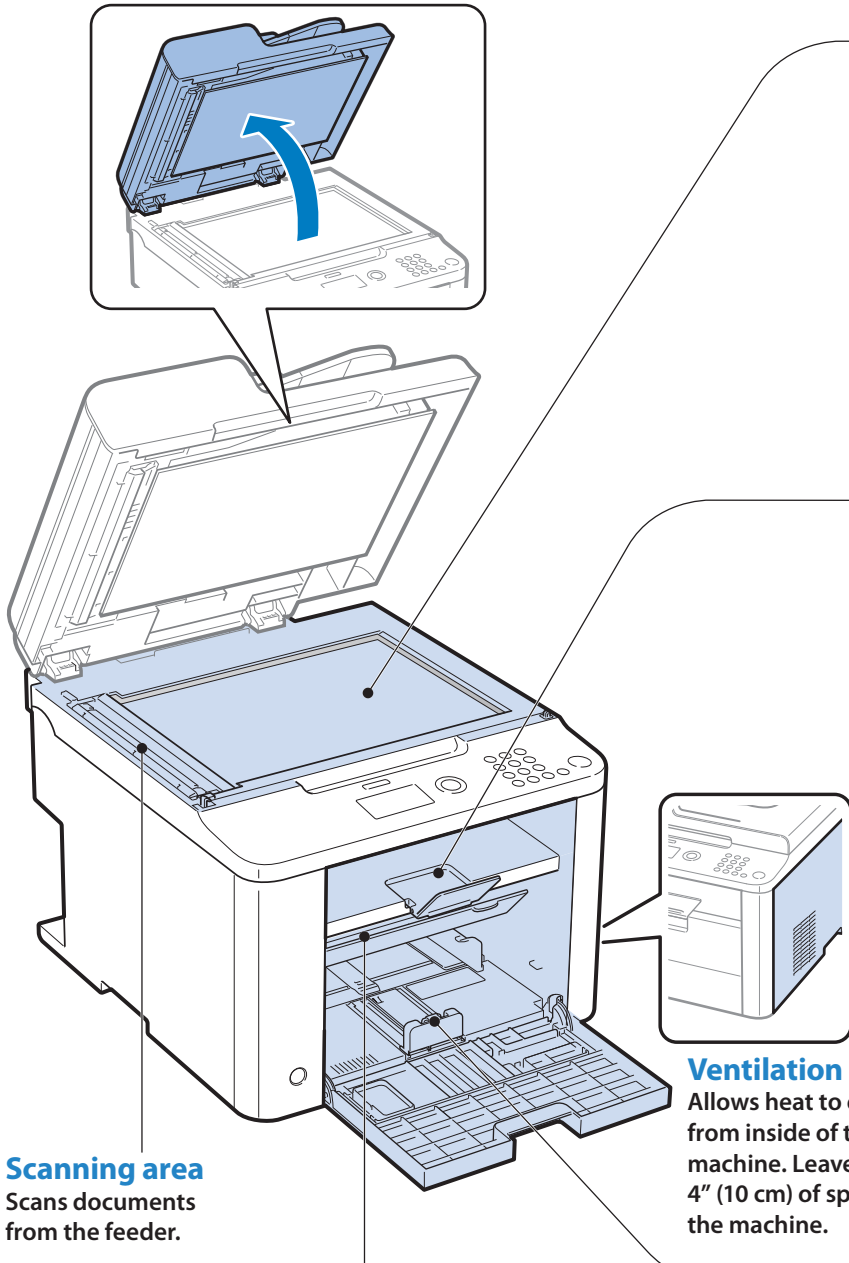

Scanning area
Scans documents from the feeder.

Multi-purpose tray
Load paper one by one manually (→P.21).

Ventilation slots
Allows heat to escape from inside of the machine. Leave more than 4" (10 cm) of space around the machine.

Platen glass
Used to scan non-standard size paper or books, as well as standard size paper (→P.17).

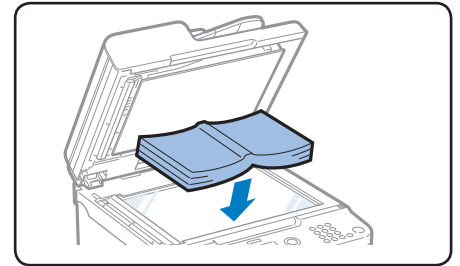

Output tray
Printed documents are output here.

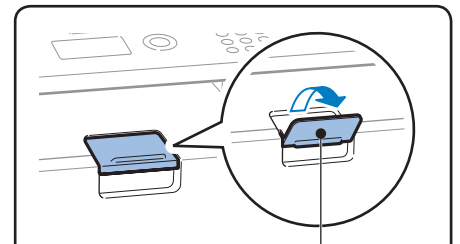

Paper stopper
Use the paper stopper to prevent paper from falling out of the output tray.

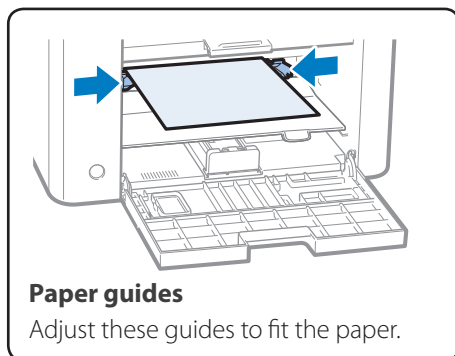

Paper guides
Adjust these guides to fit the paper.

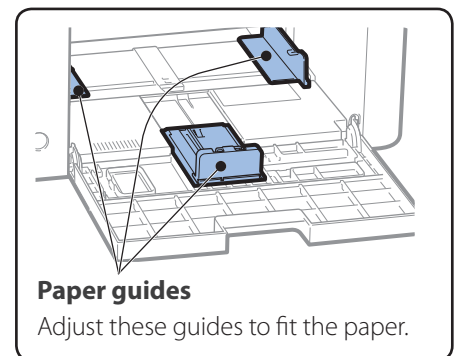

Paper guides
Adjust these guides to fit the paper.

Interior

Toner cover

Open this cover to access the toner cartridge or clear paper jams (→P.55,P.62).

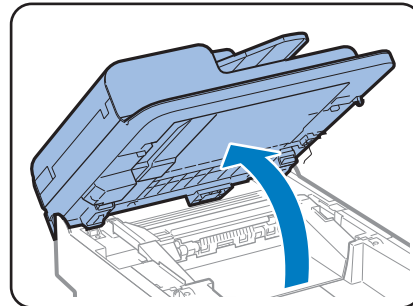
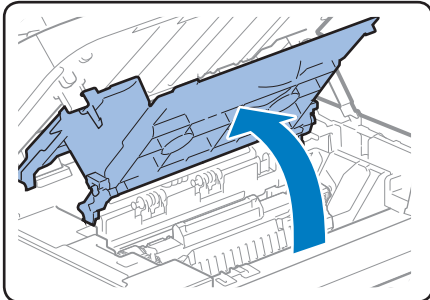

Paper exit guide

Open this guide to clear paper jams (→P.62).

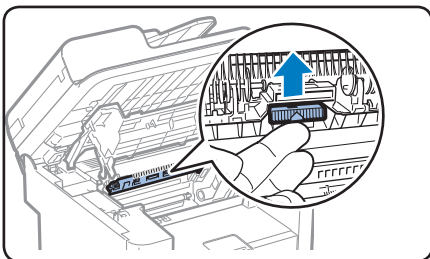

Transfer roller

Transfers toner onto paper.

Toner guides

When inserting the toner cartridge, fit the protrusions on the toner cartridge into these guides.

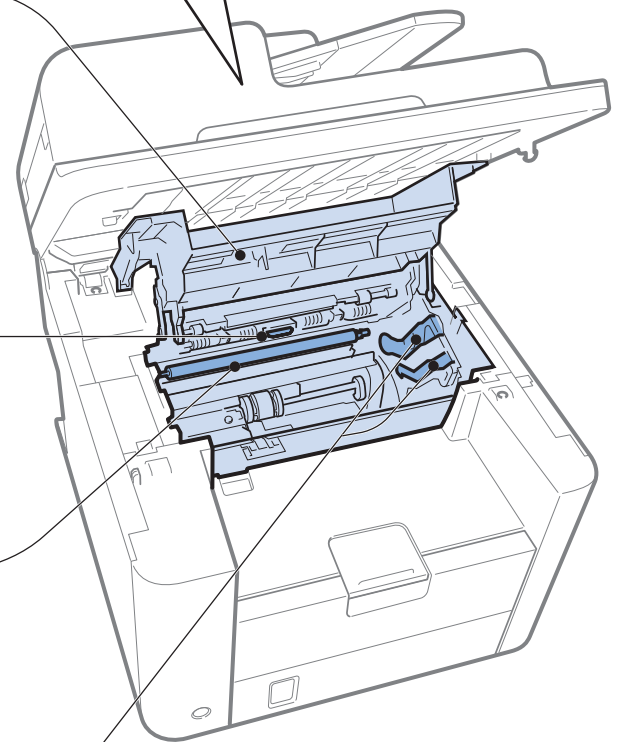
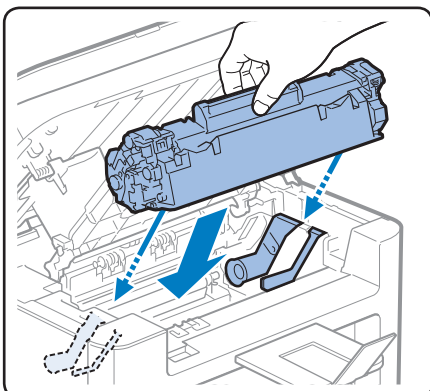

Back Side

D560

D530

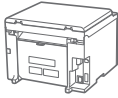
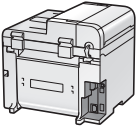

Rating label

The machine's serial number (consists of three letters and a 5-digit number) and the required voltage and current are specified.



Write the serial number on the back cover of this guide for reference when contacting the Canon Customer Center.

Serial No.	ABC
Date of Purchase	

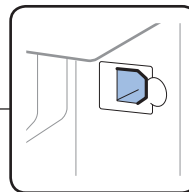
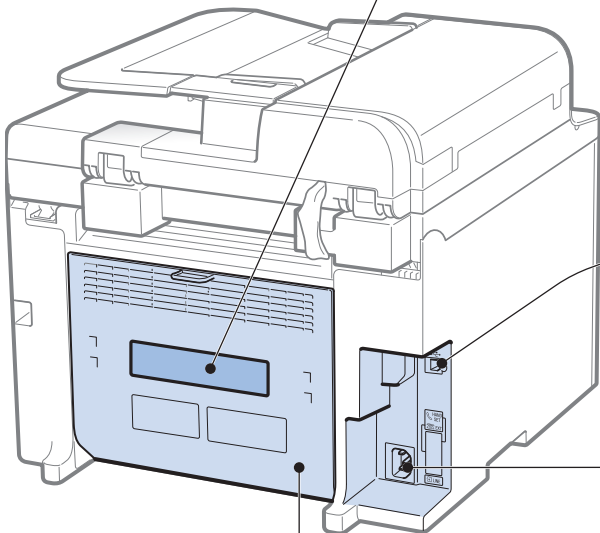

USB port

Connect to a computer via a USB cable.

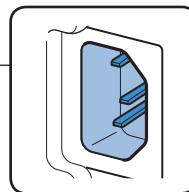

Power socket

Connect the power cord.

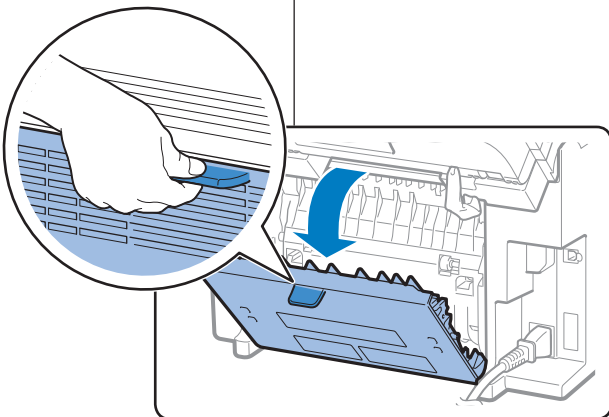

Rear cover

Open this cover to clear paper jams when using the 2-sided copy function (→P.64).

Learn the Functions of the Operation Panel

Reset	Press to reset the settings.
State Monitor/Cancel	Press to view or cancel jobs. You can also check the status of the machine (→p.34, p.42).
▲/▼	Press to scroll up and down, or to increase or decrease a value.
◀/▶	Press to return to the previous screen, proceed to the next screen, or move the cursor to the left or right.
OK	Press to confirm an
Back	Press to return to the previous screen.
Paper Settings	Press to specify paper size and type for the paper cassette or multi-purpose tray.

0 to 9 (Numeric Keys)	Press to enter letters and numbers.
*	Press to switch the character entry mode.
#	Press to enter symbols.
Quiet Mode	Press to reduce the noise when performing a job (→p.24).
Clear	Press to delete letters and numbers.

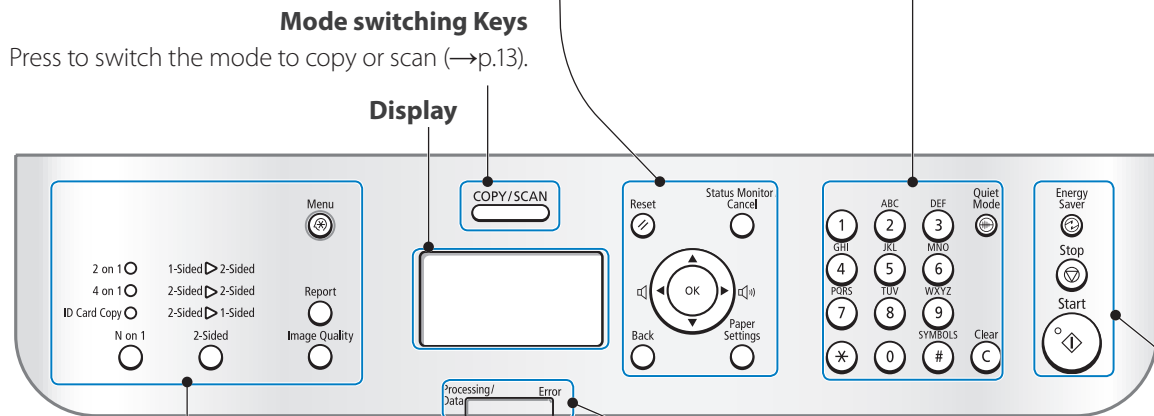

Press to switch the mode to copy or scan (→p.13).

N on 1	Press to select the setting for printing multiple documents onto one sheet. The indicator of the selected setting will be lit up and also the item will be displayed on the LCD.
2-Sided	Press to select the setting for printing on both sides of paper. The indicator of the selected setting will be lit up and also the item will be displayed on the LCD.
Menu	Press to access menu functions (see "Navigating the Menu" at the bottom of the next page).
Report	Press to manually print reports and lists (→p.58).
Image Quality	Press to select the image quality for copying.

Processing/Data indicator

Blinks during transmission and turns on when the machine has waiting jobs.

Error indicator

The indicator blinks when an error occurs.

Energy Saver	Press to manually set or cancel the Sleep mode. The Energy Saver indicator lights green while in the Sleep mode (→p.24).
Stop	Press to cancel jobs.
Start	Press to start copying or scanning.

Navigating the Menu

Example: Adjust the density

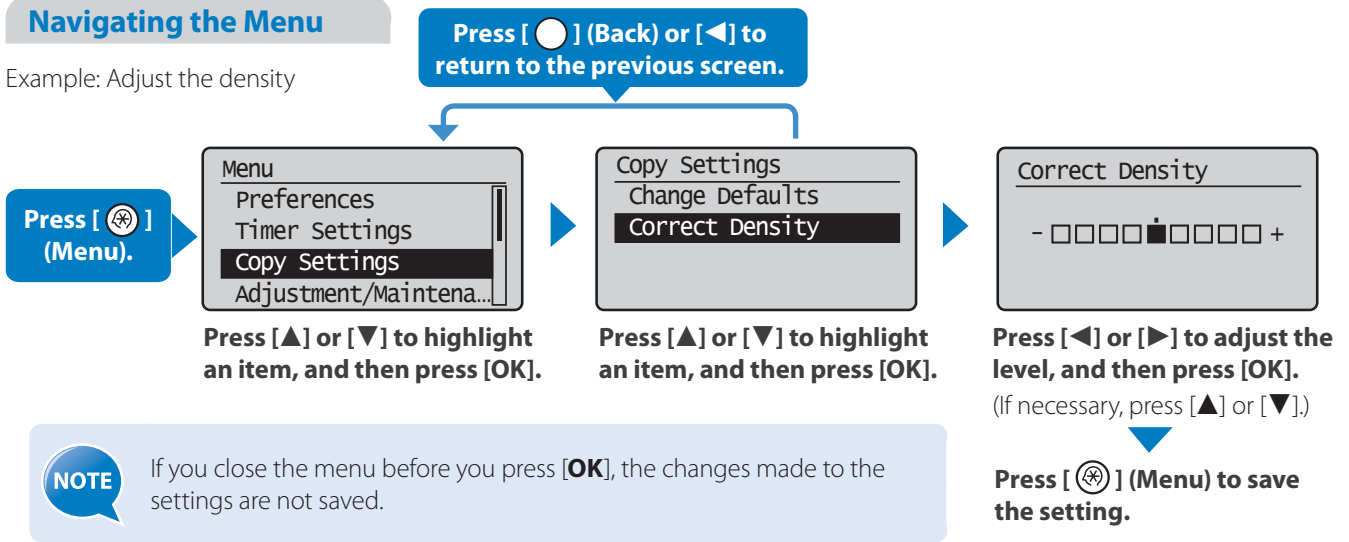

Switch to Copy or Scan Mode

Switch to Copy or Scan mode first to use each mode.

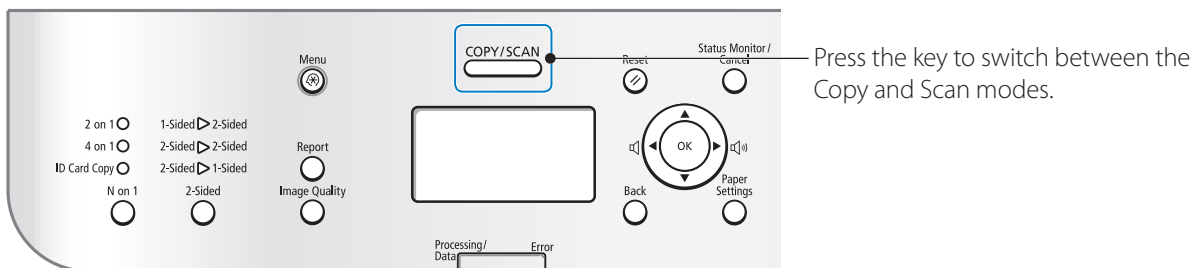

▼ If you do not operate the machine for a while, the machine returns to the Copy mode (standby mode) automatically.

Copy Mode

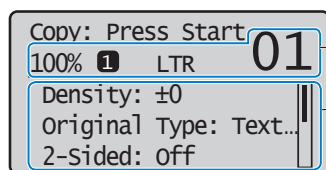

Displays the copy ratio, paper source, paper size, and number of copies.

To change the settings:

1. Press [▲] or [▼] to highlight an item, and then press [OK].
2. Press [▲], [▼], [◀] or [▶] to specify the values, and then press [OK].

Scan Mode

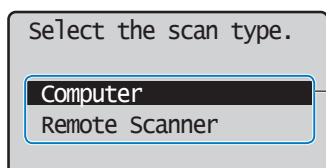

To select the scan method:

Press [▲] or [▼] to highlight an item, and then press [OK].



To specify how long the machine waits before returning to standby mode:

Press [⊗] (Menu) → <Timer Settings> → <Auto Reset Time> → Specify the time → [OK].

Enter Text

Enter characters with the alphanumeric keys.

To switch entry modes:

<A>	Uppercase alphabetic letters and symbols
<a>	Lowercase alphabetic letters and symbols
<12>	Numbers

Press [*****] (*) repeatedly.
or

1. Press [**▲**] or [**▼**] to highlight <Entry Mode>, and then press [**OK**].
2. Press [**▲**] or [**▼**] to highlight the desired mode, and then press [**OK**].

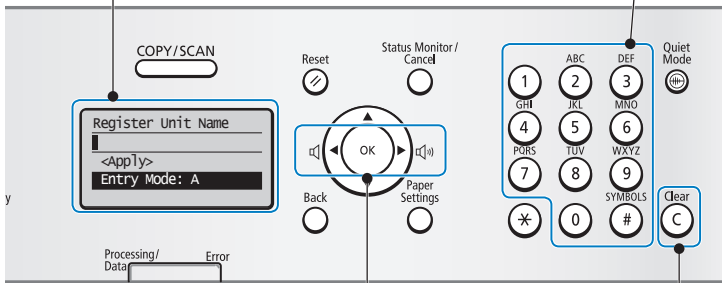

To enter text, symbols, and numbers:

Press a key several times until the desired character is displayed.

Key	Entry mode: <A>	Entry mode: <a>	Entry mode: <12>
①	@-_/		1
②	ABC	abc	2
③	DEF	def	3
④	GHI	ghi	4
⑤	JKL	jkl	5
⑥	MNO	mno	6
⑦	PQRS	pqrs	7
⑧	TUV	tuv	8
⑨	WXYZ	wxyz	9
⑩	(Not available)		0
#	- . * # ! " , ; : ^ ` _ = / ' ? \$ % & + \ () [] { } < >		(Not available)

- Press to move the cursor.
- To enter a space, move the cursor to the end of the text, and then press [**▶**].
- Press to delete the last character.
- Press and hold to delete all text.

Example: Enter "CANON1"

Press [*****] to switch the entry mode to <A>.

Press [②] until the letter "C" appears on the screen.

Press [②] until the letter "A" appears on the screen.

Press [⑥] until the letter "N" appears on the screen.

Press [⑥] until the letter "O" appears on the screen.

Press [⑥] until the letter "N" appears on the screen.

Press [*****] to switch the entry mode to <12>.

Press [①] to enter "1."

Set Date and Time

If the incorrect date or time is printed on reports, change the date and time settings.

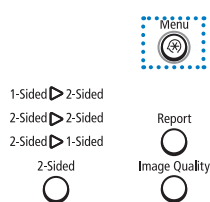

- 1 Press [Ⓜ] (Menu).
- 2 Press [▲] or [▼] to highlight <Timer Settings>, and then press [OK].
- 3 Press [▲] or [▼] to highlight <Time & Date Settings>, and then press [OK].

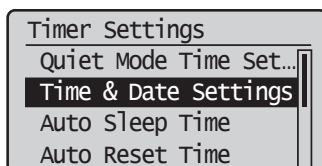

- 4 Press [▲] or [▼] to highlight <Current Time Settings>, and then press [OK].
 - To change the display format for the date or time, specify <Date Display Type> or <12/24 Hour Clock>.
 - To use daylight savings time, set <Daylight Savings> to <On>, and then specify the starting date and the ending date.
- 5 Use the numeric keys to enter the date and time, and then press [OK].
 - To move the cursor, press [◀] or [▶].
 - To switch between <AM> or <PM>, press [▲] or [▼].

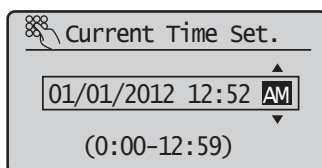

- 6 Press [Ⓜ] (Menu) to close the screen.

Place Documents

Choose the appropriate way to place documents according to the document's type.

When placing non-standard documents such as heavy paper, small paper, or booklets:



Use the platen glass (→p.17).

Check available documents

Size (Width X Length)	<p>Maximum</p>
Weight	<p>Maximum 4.4 lb (2 kg)</p>
Capacity	<p>1 sheet</p>

When placing multiple documents of plain paper in the same size, thickness, and weight:

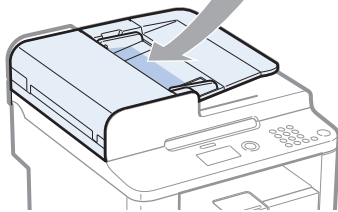

Use the feeder (→p.17).

Check available documents

Size (Width X Length)	
Capacity (For 21 lb Bond (80 g/m²))	<p>50 Sheets</p>
Weight	<p>1-sided documents 13.3 to 27.9 lb Bond (50 to 105 g/m²) 2-sided document 16.0 to 27.9 lb Bond (60 to 105 g/m²)</p>

* D530 is not equipped with the feeder.

IMPORTANT

- Place a document after glue, ink, or correction fluid on the document is completely dry.
- To prevent paper jams in the feeder, place a document on the platen glass when using the following types of paper:
 - Wrinkled or creased paper
 - Carbon paper or carbon-backed paper
 - Curled or rolled paper
 - Torn paper
 - Thin paper
 - Documents with staples or paper clips attached
 - Transparency

Placing Documents on the Platen Glass

- 1 Open the feeder or the platen glass cover.
- 2 Place your document face down.

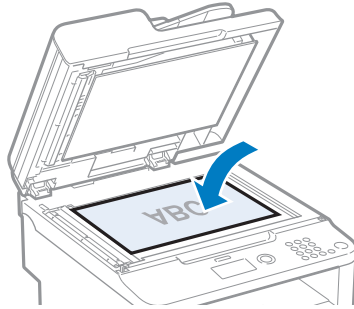

- 3 Align the document with the appropriate paper size marks.

- If the document does not match any of the paper size marks, align the upper left edge of your document with the arrow mark.
- If the document is a transparency, place white paper above the document.

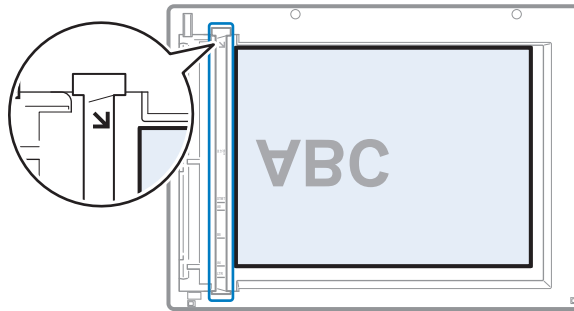

- 4 Close the feeder or the platen glass cover.

CAUTION

- When closing the feeder, be careful not to get your fingers caught.
- Do not press down on the feeder forcefully. This may damage the platen glass and cause personal injury.

Placing Documents in the Feeder (D560 Only)

- 1 Spread the document guides a little wider than the document's width.

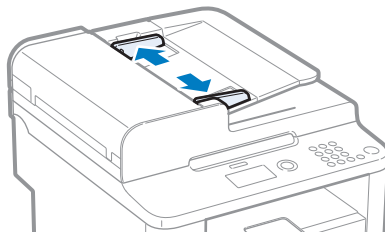

- 2 Fan the document stack and align the edges of the pages.

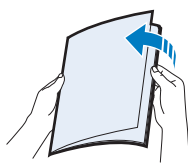

Thoroughly fan the paper in small batches.

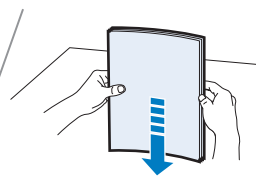

Align the edges a few times on a flat surface.

3 Neatly place the documents face up.

- Do not exceed the load limit guides (A).
- Make sure that the paper stack does not exceed the load limit marks (B).

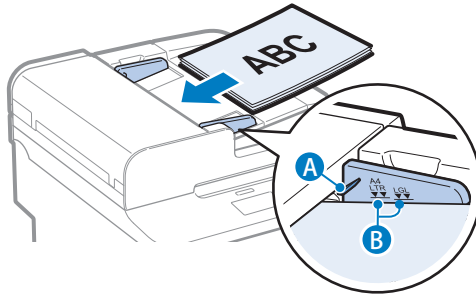

4 Align the document guides tightly to the width of the document.

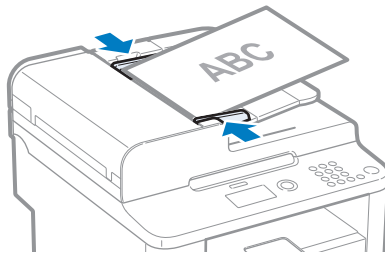

If the document guides are too loose or too tight, this may result in misfeeds or paper jams.



- While scanning documents, do not add or remove documents.
- When scanning is complete, remove the document from the document return tray to avoid paper jams.
- Do not scan the same document more than 30 times. When a document is scanned repeatedly, the paper can become wrinkled, earmarked, or torn, which may result in paper jams.

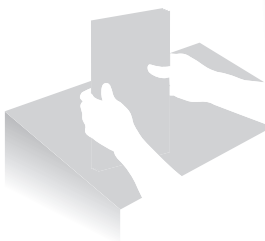

Load Paper

Before loading paper, check the paper is the right type. If you load inappropriate paper repeatedly, this may cause paper jams.

Step 1 Check if the type of paper is appropriate.

Paper such as Legal, Letter, Statement, Executive, and envelopes can be used. For details about the available paper or precautions, see [Basic Operation] → [Loading paper] in the e-Manual.

NOTE

To prevent paper jams, do not use any of the following:

- Wrinkled or creased paper
- Curled or rolled paper
- Torn paper
- Damp paper
- Paper printed with a thermal transfer printer (Do not copy on the reverse side.)

Step 2 Select where to load paper, and then load the paper.

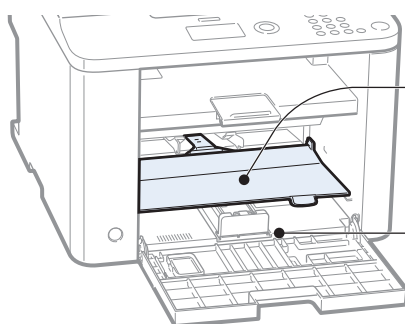

Use the multi-purpose tray when loading a sheet of small-sized paper or heavy paper (→p.21).



Use the paper cassette when loading a stack of plain paper in the same size, thickness, and weight (→p.20).

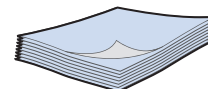

Step 3 Check if the type of paper is appropriate.

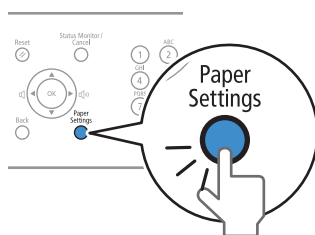

NOTE

If the setting is different from the size of the loaded paper, an error message appears, or printing is not performed correctly.

Loading Paper in the Paper Cassette

This section describes how to load letter paper in the Paper Cassette. When loading envelopes or paper with a letterhead, see "Loading Envelopes or Paper with a Letterhead" (→p.22).

- 1 Open the front cover and the lower front cover.

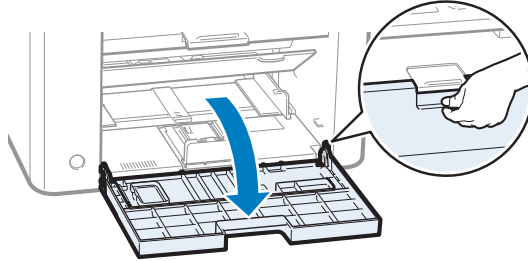

- 2 Spread the paper guides a little wider than the paper size.

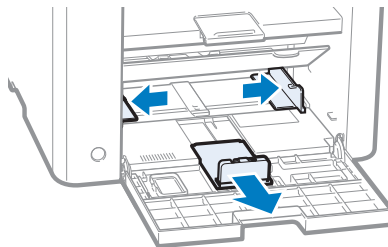

- 3 Gently load the paper into the paper cassette with the print side face up, until the edge of the paper stack meets the back of the paper cassette.

- Make sure that the paper stack does not exceed the load limit guides (A).

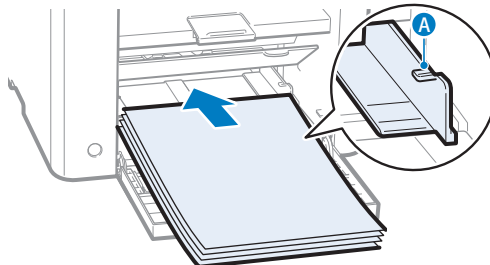

- 4 Adjust the paper guides tightly to the width and length of the paper.

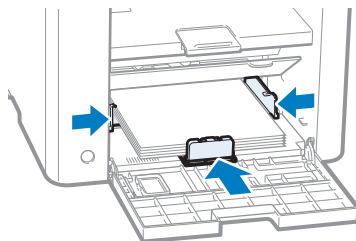

IMPORTANT

If the paper guides are too loose or too tight, this may result in misfeeds or paper jams.



- 5 Close the front cover and the lower front cover.
- 6 Specify the loaded paper size and type (→p.23).

Loading Paper in the Multi-Purpose Tray

- 1 Open the front cover and the lower front cover.

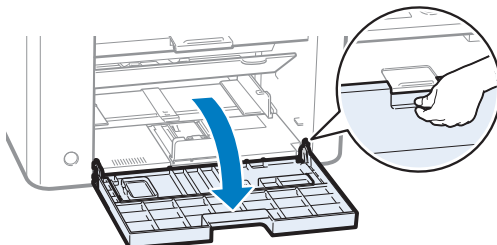

- 2 Push down and lower the multi-purpose tray.

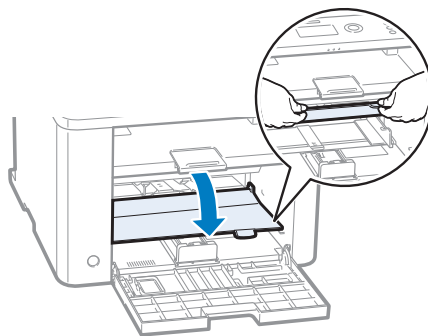

- 3 Spread the paper guides a little wider than the paper.

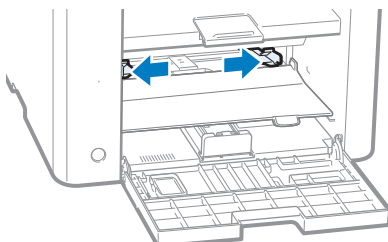

- 4 Gently load the paper into the multi-purpose tray with the print side face up, and adjust the paper guides tightly to the width of the paper.

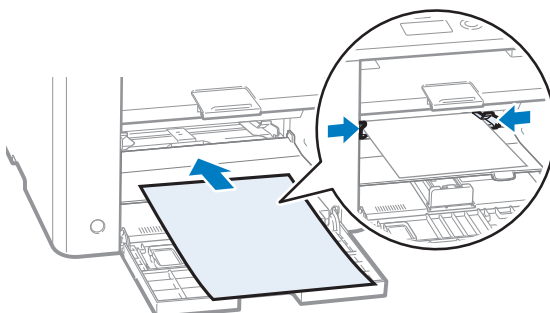

- 5 Specify the loaded paper size and type (→p.23).

Loading Envelopes or Paper with a Letterhead

This section describes how to load envelopes and paper with a letterhead.

Envelopes

Before Loading

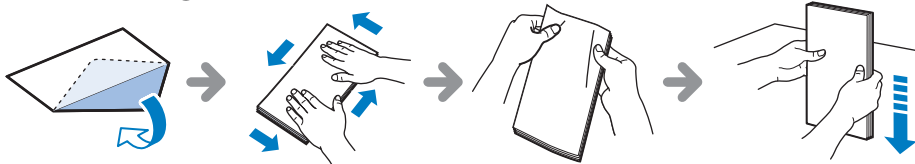

Flatten envelopes to release any remaining air.

Loosen any stiff corners of the envelopes, and flatten any curls, as shown in the figure.

Loading Orientation

Load the envelopes with the flaps face up.

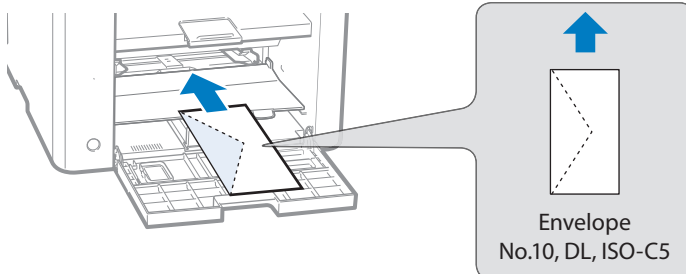

Paper with a Letterhead or Logo

Loading Orientation

Load the paper properly by following the instructions below.

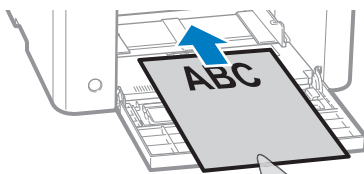

1-sided printing

Load the paper with the printed side face up.



When printing with portrait layout

When printing with landscape layout

2-sided printing

Load the paper with the printed side face down.

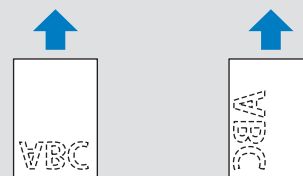

When printing with portrait layout

When printing with landscape layout



If **<Print Side Priority>** is selected, load the paper with the printed side face down regardless of 1-sided or 2-sided printing. For details, see **[Basic Operation]** → **[Select the Print Side]** in the e-Manual.

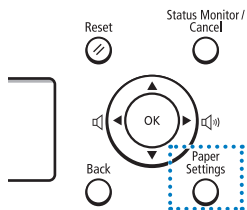

Setting a Paper Size and Type

Make sure that the Paper Settings match the size and the type of the loaded paper.

- 1 Press [○] (Paper Settings).
- 2 Press [▲] or [▼] to highlight <MP Tray> or <Drawer 1>, and then press [OK].
- 3 Press [▲] or [▼] to highlight the desired paper size, and then press [OK].
 - To specify the paper size manually, select <Custom Size>, and then refer to "Specify a Paper Size Manually" at the bottom of this page to specify the size.

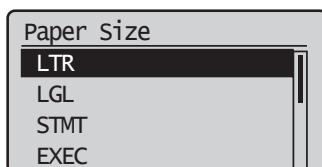

- 4 Press [▲] or [▼] to highlight the desired paper type, and then press [OK].

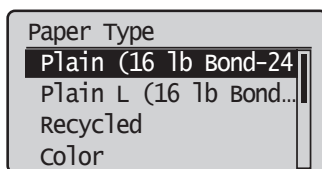

- 5 Press [○] (Paper Settings) to close the screen.

Specify a Paper Size Manually

For paper size, specify within the possible range of length and width (<Y> ≥ <X>).

- 1 Press [▲] or [▼] to highlight <X>, and then press [OK].
- 2 Use the numeric keys to specify the width, and then press [OK].

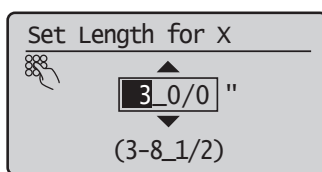

- 3 Press [▲] or [▼] to highlight <Y>, and then press [OK].
- 4 Use the numeric keys to specify the length, and then press [OK].
- 5 Press [▲] or [▼] to highlight <Apply>, and then press [OK].

Switch to the Quiet Mode

You can switch to and cancel the Quiet mode, by pressing [] (Quiet Mode).

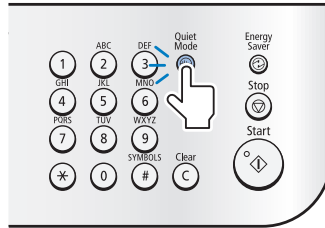

NOTE

- By default, the Quiet mode is set to **<Off>**. To change this setting to **<On>**, and specify the time to switch to the Quiet mode automatically, press [] (Menu) ➔ **<Timer Settings>** ➔ **<Quiet Mode Time Settings>**, and then specify a time.
- When the Quiet mode is On, the processing speed of functions becomes slower.
- The Quiet mode cannot be used with some paper sizes or types.
- The Special mode has higher priority than the Quiet mode.
- The Quiet mode only reduces noise that occurs while the machine is performing jobs.

Switch to the Sleep Mode

You can switch to and cancel the Sleep mode, by pressing [] (Energy Saver).

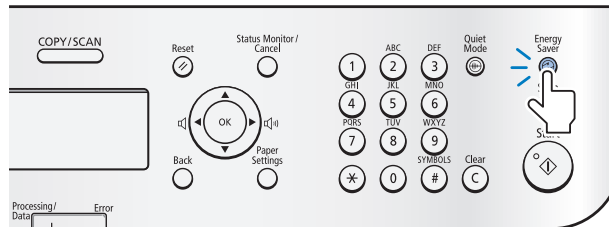

When the Processing/Data indicator is lit or blinking, the machine will not enter the Sleep mode, because an operation is in progress or an error has occurred.

NOTE

- By default, the machine automatically enters the Sleep mode if you do not perform any functions for 5 minutes. To change this setting, press [] (Menu) ➔ **<Timer Settings>** ➔ **<Auto Sleep Time>**, and then specify a time.

Use the Toner Saver Mode

You can set whether or not to conserve toner when copying. When using the Toner Saver mode, the output may not be clear, as subtle details, such as thin lines and light colors, may not be clearly reproduced.

- 1 Press [] (Menu).
- 2 Press [▲] or [▼] to highlight <Preferences>, and then press [OK].
- 3 Press [▲] or [▼] to highlight <Toner Saver Mode>, and then press [OK].

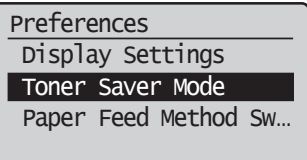

- 4 Press [▲] or [▼] to highlight <Copy>, and then press [OK].
- 5 Press [▲] or [▼] to highlight <On> or <Off>, and then press [OK].
- 6 Press [] (Menu) to close the screen.

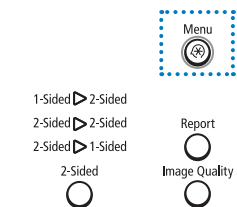

Memo

Copy

This chapter describes basic copy functions.



Make a Basic Copy	28
Enlarge or Reduce Copies	29
Adjust the Image Quality for Copy	29
Adjusting the density	29
Selecting the Document Type	30
Adjusting the sharpness	30
Make Double-Sided Copies	31
Copy Multiple Pages onto One Sheet	32
Collate Copies	32
Copy a Double-Sided ID Card	33
View and Cancel Copy Jobs	34
Change the Default Copy Settings	34

Make a Basic Copy

- 1 Place your documents (→p.16).

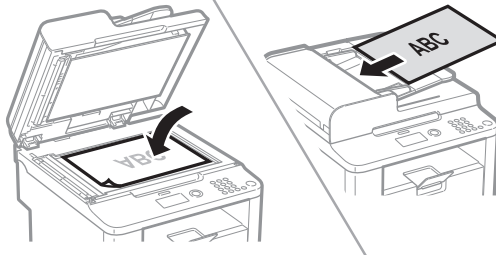

* D530 is not equipped with the feeder.



If the document guides are too loose or too tight, this may result in misfeeds or paper jams.

- 2 Switch to the Copy mode (→p.13).
- 3 Enter the desired copy quantity (1 to 99) with the alphanumeric keys.
 - Press [C] (Clear) to delete the entered copy quantity.

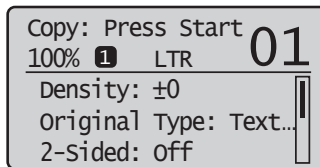

- 4 Press [Start] (Start).

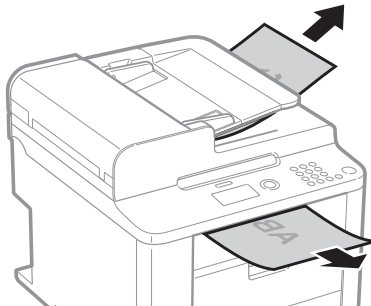

Canceling Copy Jobs

Press [Stop] (Stop) twice.

* It is valid when only one job is processing or waiting.

Enlarge or Reduce Copies

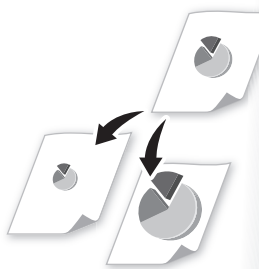

Enlarge or reduce copies using preset copy ratios or custom copy ratios.

- 1 Place your documents (→p.16).
- 2 Switch to the Copy mode (→p.13).
- 3 Press [▲] or [▼] to highlight <Copy Ratio>, and then press [OK].
- 4 Press [▲] or [▼] to highlight the desired ratio, and then press [OK].
 - If you want to set a copy ratio in 1% increments, select <Custom Ratio>, and then enter the copy ratio using the numeric keys or press [▲] or [▼] to specify the ratio.

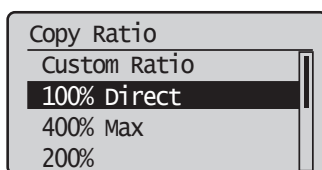

- 5 Press [⏻] (Start).

Adjust the Image Quality for Copy



Relation between the density and document type:

If <Density> is set to <Auto Density>, <Original Type> will be changed to <Text>.

Adjusting the density

You can make the density brighter or darker than the original documents.



- 1 Place your documents (→p.16).
- 2 Switch to the Copy mode (→p.13).
- 3 Press [▲] or [▼] to highlight <Density>, and then press [OK].
- 4 Press [◀] or [▶] to adjust the density, and then press [OK].
 - Select <Auto Density> to use the density that is most suitable for the document.

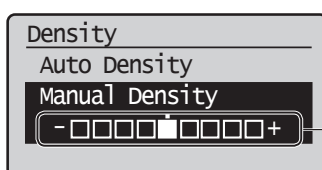

- : Less density (lighter)
+ : More density (darker)

- 5 Press [⏻] (Start).

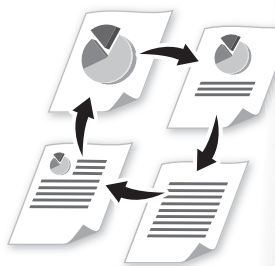

Selecting the Document Type

Select the appropriate document type.

- 1 Place your documents (→p.16).
- 2 Switch to the Copy mode (→ p.13).
- 3 Press [▲] or [▼] to highlight <Original Type>, and then press [OK].
- 4 Press [▲] or [▼] to highlight the appropriate document type, and then press [OK].

<Text>	Best suited for text-only documents.
<Text/Photo (High Speed)>	Suitable for documents that contain text and photos. (Scanned documents are at a low resolution at high speed.)
<Text/Photo>	Suitable for documents that contain text and photos.
<Photo>	Suitable for documents that contain large photos.

- 5 Press [⊕] (Start).

Adjusting the sharpness

You can sharpen or soften the edges of images by adjusting the sharpness.



- 1 Place your documents (→p.16).
- 2 Switch to the Copy mode (→p.13).
- 3 Press [▲] or [▼] to highlight <Sharpness>, and then press [OK].
- 4 Press [◀] or [▶] to adjust the sharpness, and then press [OK].

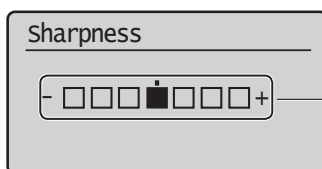

- : Less sharpness (Suitable for photos)
- + : More sharpness (Suitable for documents written in pen or pencil)

- 5 Press [⊕] (Start).

Make Double-Sided Copies



You can make double-sided copies from single-sided documents. When using the D560, you can also make double-sided or single-sided copies from double-sided documents.

1 Place your documents (→p.16).

- To make double-sided copies from single-sided documents, place the documents in the feeder or on the platen glass.
- To make double-sided or single-sided copies from double-sided documents, place documents in the feeder. (D560 only)

2 Switch to the Copy mode (→p.13).

3 Press [○] (2-Sided) until the indicator of desired 2-Sided copy format is lit.

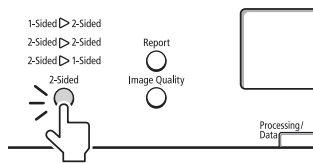

- If you press [OK], and then select **<Format Settings>**, you may specify the orientation of your documents and the desired finishing format.



<Calendar Type>



<Book Type>

4 Press [⊕] (Start).

When placing your documents in the feeder	Copying starts automatically.
When placing your documents on the platen glass	<ol style="list-style-type: none"> 1. Press [▲] or [▼] to highlight the size of the original document, and then press [OK]. <ul style="list-style-type: none"> • You may specify the scan size as <LGL> size, but the actual size is <A4> size. 2. Place the next page on the platen glass, and then press [⊕] (Start). <ul style="list-style-type: none"> • Press [⊕] (Start) for every scanning. 3. After scanning all your documents, press [▲] or [▼] to highlight <Start Copying>, and then press [OK].

Copy Multiple Pages onto One Sheet

You can combine multiple pages (two or four pages) onto one copy sheet.



- 1 Place your documents (→p.16).
- 2 Switch to the Copy mode (→p.13).
- 3 Press [○] (N on 1) until the indicator of desired format is lit.
 - To specify the page layout, press [OK], and then select <Select Layout>.

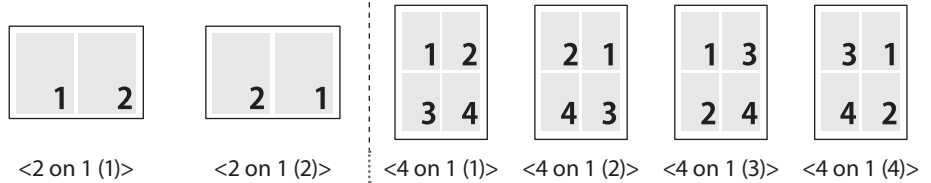

- To specify the scan size, press [OK], and then select the desired scan size.
- You may specify the scan size as <LGL> size, but the actual size is <A4> size.

- 4 Press [⊕] (Start).

Collate Copies

You can arrange copies into sets arranged in page order by using the <Collate> function when making multiple copies of multiple documents.

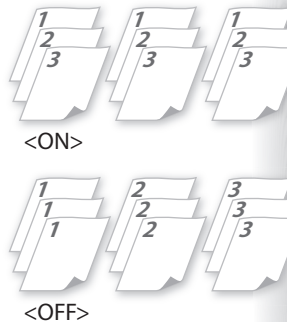

- 1 Place your documents (→p.16).
- 2 Switch to the Copy mode (→p.13).
- 3 Press [▲] or [▼] to highlight <Collate>, and then press [OK].
- 4 Press [▲] or [▼] to highlight <On>, and then press [OK].
- 5 Press [⊕] (Start).

Copy a Double-Sided ID Card

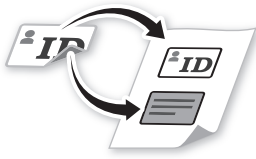

You can make a copy of a double-sided ID card onto single-sided paper.

1 Place an ID on the platen glass.

- Place the card at the center of the left edge of the platen glass, with a 1/4" (5 mm) space created.

To place the card horizontally

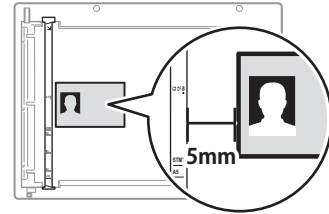
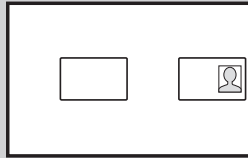

To place the card vertically

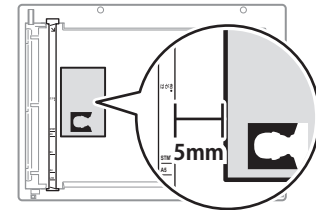
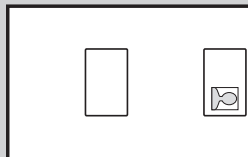

2 Switch to the Copy mode (→p.13).

3 Press [○] (N on 1) until the indicator of ID Card Copy is lit.

4 Press [⏻] (Start).

5 Turn and place the card.

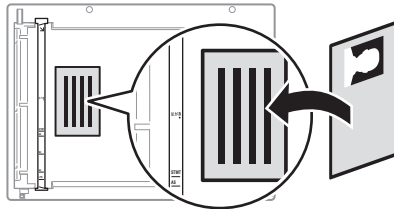

6 Press [⏻] (Start).

NOTE

- The copy ratio is automatically set to <100%>.
- You can only use Letter size or larger paper for ID card copying.

View and Cancel Copy Jobs

You can view or cancel copy jobs while the jobs are in progress.

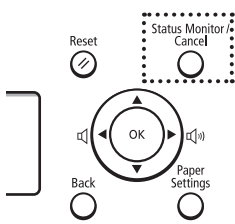

- 1 Press [○] (Status Monitor/Cancel).
- 2 Press [▲] or [▼] to highlight <Copy Job Status>, and then press [OK].
- 3 View the details of a copy job or cancel the job.
 - To view the details, press [▲] or [▼].
 - To cancel the job, press [▲] or [▼] to highlight <Cancel>, and then press [OK].

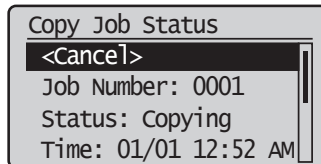

- 4 Press [○] (Status Monitor/Cancel) to close the screen.

Change the Default Copy Settings

You can change the default copy settings that are applied when the machine is restarted, [⊗] (Reset) is pressed or the screen is returned to the default screen after auto reset is performed.

- 1 Press [⊗] (Menu).
- 2 Press [▲] or [▼] to highlight <Copy Settings>, and then press [OK].
- 3 Press [▲] or [▼] to highlight <Change Defaults>, and then press [OK].
- 4 Press [▲] or [▼] to highlight the desired option, and then press [OK].

<No. of Copies>	Select the copy quantity.
<Density>	Make the density lighter or darker.
<Original Type>	Select the image quality.
<2-Sided>	Copy 1-sided document to 2 sides.
<Copy Ratio>	Select the copy ratio.
<N on 1>	Copy multiple documents onto one sheet.
<Collate>	Collate copies of a complete copy job arranged in page sequential order or by page.
<Sharpness>	Emphasize the outline of the image or decrease the contrast.

- 5 Specify the desired setting.
- 6 After you have specified the setting, press [▲] or [▼] to highlight <Apply>, and then press [OK].
- 7 Press [⊗] (Menu) to close the screen.

Print

This chapter describes basic print functions.

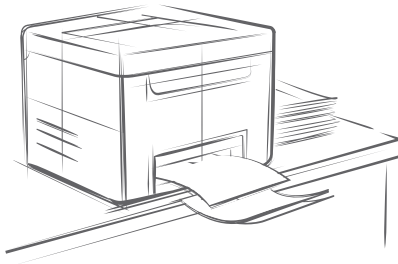

Print a Document	36
Enlarge or Reduce a Document	36
Print a Double-Sided Document	37
Print Multiple Pages onto One Sheet	38
Print a Booklet.....	39
Print a Poster	40
Add Watermarks to a Printout	41
View and Cancel Print Jobs.....	42



Before using the printing functions, connect the machine to a computer and install the printer driver on the computer. See the Starter Guide to learn how to install the printer driver.



- You cannot specify printing options with the printer driver and another application at the same time.
- Your computer screen may differ from the images shown here, depending on your operating system and the type and version of the printer driver.

Print a Document

- 1 Make sure that a computer and the machine are connected properly, and the printer driver is installed on the computer.
- 2 Open a document from an application, and then open the Print window.
- 3 Select your printer driver, and click [Preferences] (or [Properties]).

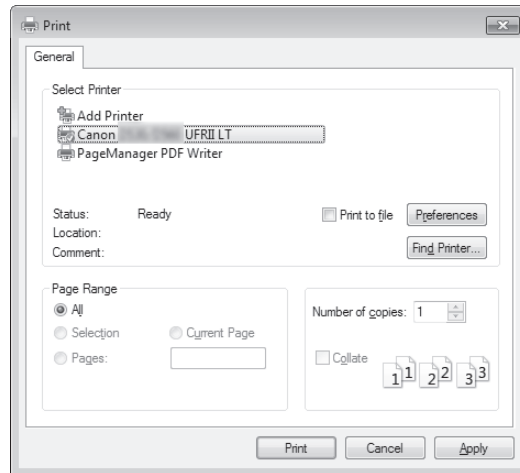

- 4 Specify the print settings such as the number of copies and print orientation, and click [OK].
- 5 Click [Print] to start printing.

Canceling Print Jobs

Press [⏹] (Stop) twice.

* It is valid when only one job is processing or waiting.

Enlarge or Reduce a Document

You can enlarge or reduce the data to fit the paper size automatically, or specify a custom ratio.

- 1 Open a document from an application, and then open the Print window.
- 2 Select your printer driver, click [Preferences] (or [Properties]), and display the Printing Preferences window.

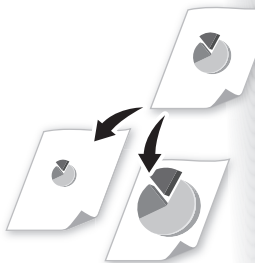

3 Click the [Basic Settings] tab, and then specify the print ratio.

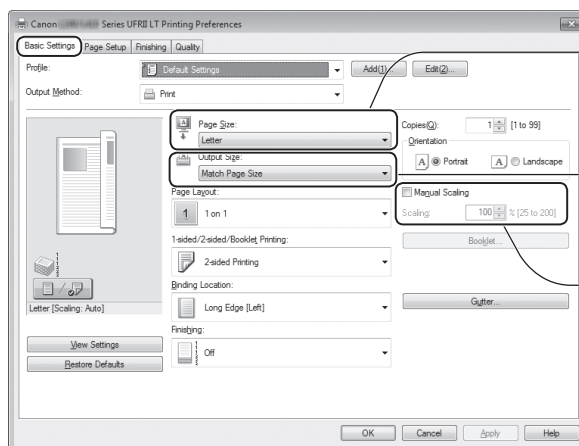

Select the paper size of the document.

To automatically scale the document to fit the loaded paper, select an output size.

To specify the print ratio manually, select **[Manual Scaling]**, and then specify the scaling ratio.

4 Click [OK] to return to the Print window.

5 Click [OK] to start printing.

Print a Double-Sided Document



You can print on both sides of paper.

1 Open a document from an application, and then open the Print window.

2 Select your printer driver, click [Preferences] (or [Properties]), and display the Printing Preferences window.

3 Click the [Basic Settings] tab, and then specify the settings for double-sided printing.

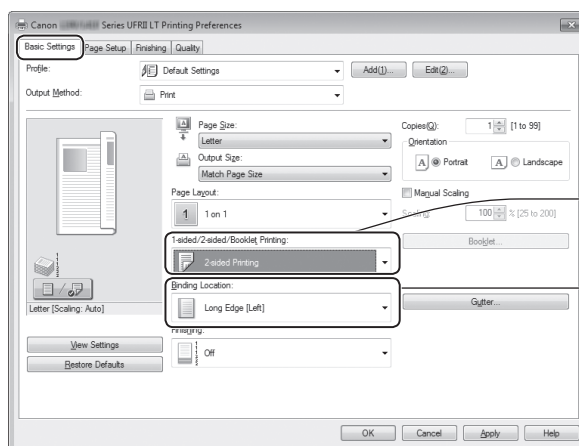

Select **[2-sided Printing]**.

Select the binding edge.

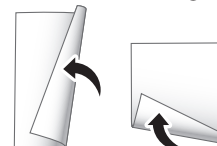

4 Click [OK] to return to the Print window.

5 Click [OK] to start printing.



Supported document sizes for double-sided printing varies depending on the models. For details, see **[Specifications]** ➔ **[Supported Paper Types]** in the e-Manual.

Print Multiple Pages onto One Sheet

You can reduce and print 2, 4, 6, 8, 9, or 16 pages of an original document onto a single sheet of paper. This feature allows you to save paper or to view several pages at once.

- 1 Open a document from an application, and then open the Print window.
- 2 Select your printer driver, click [Preferences] (or [Properties]), and display the Printing Preferences window.
- 3 Click the [Basic Settings] tab, and then specify the number of pages and a page layout.

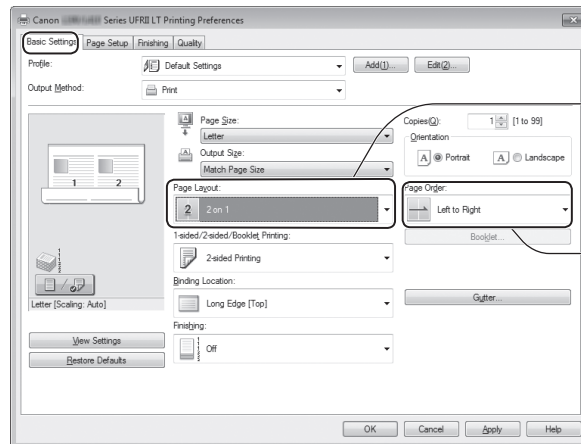

- Select the number of pages to print on a single page.
- Select the page layout.

- 4 Click [OK] to return to the Print window.
- 5 Click [OK] to start printing.

NOTE

You cannot enlarge or reduce the documents manually when using this function.

Print a Booklet



You can print pages side-by-side, and then fold them to create a booklet.

- 1 Open a document from an application, and then open the Print window.
- 2 Select your printer driver, click [Preferences] (or [Properties]), and display the Printing Preferences window.
- 3 Click the [Basic Settings] tab, select [Booklet Printing], and then click [Booklet].

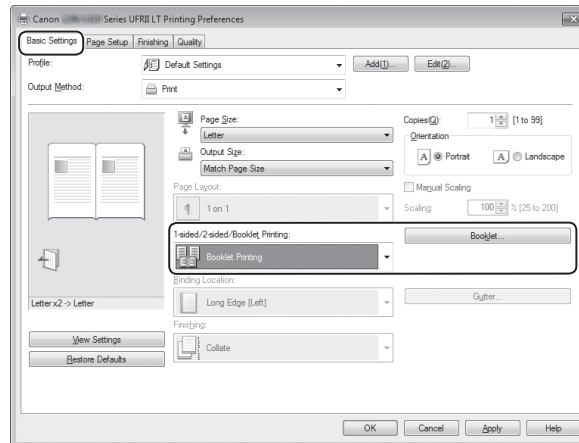

- 4 Specify the settings for the booklet, and then click [OK].

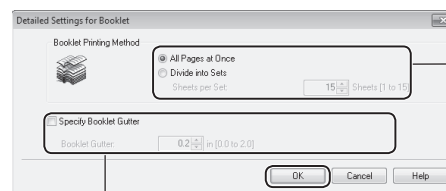

You can choose to print all pages at once or print sets of pages according to the specified number of pages.

To specify the margin for binding, select the check box, and then enter the value.

- 5 Click [OK] to return to the Print window.
- 6 Click [OK] to start printing.
- 7 Make a booklet by folding the printouts in half.

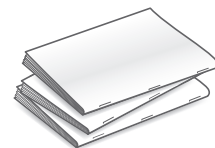

Print a Poster

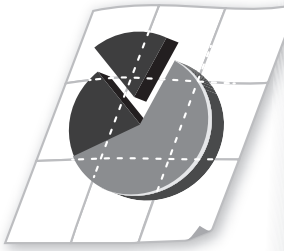

You can enlarge a one-page document and print it on multiple pages. You can then combine the printed pages to create a large poster.

- 1 Open a document from an application, and then open the Print window.
- 2 Select your printer driver, click [Preferences] (or [Properties]), and display the Printing Preferences window.
- 3 Click [Basic Settings] tab, and then select [Poster(N×N)] from the [Page Layout] drop-down menu.

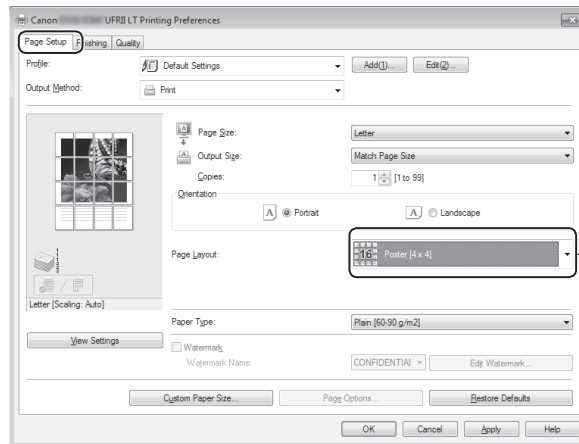

Select **[Poster [N×N]]** (N×N is split numbers of divided pages wide by high).

- 4 Click [OK] to return to the Print window.
- 5 Click [OK] to start printing.
- 6 Make a poster by gluing or taping the printouts together.



NOTE

You cannot combine this feature with watermark printing, manual scaling, or printing multiple pages onto one sheet.

Add Watermarks to a Printout



You can add watermarks, such as "DRAFT," to a document.

- 1 Open a document from an application, and then open the Print window.
- 2 Select your printer driver, click [Preferences] (or [Properties]), and display the Printing Preferences window.
- 3 Click the [Page Setup] tab, and then specify the settings for watermark printing.

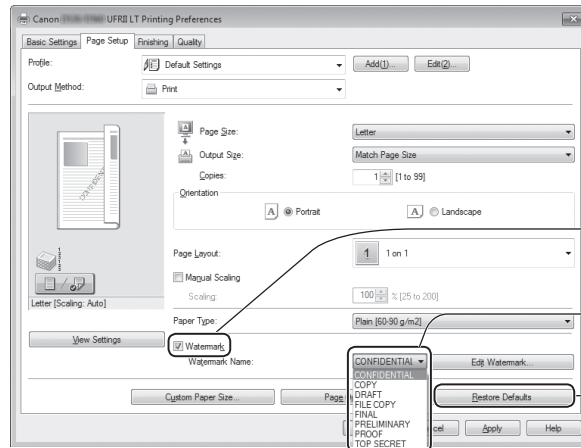

- Select to add watermarks.
- Select the desired watermark.
- Select to create a new original stamp.

- 4 To create a new original watermark, click [Edit Watermark], and then enter the new text.

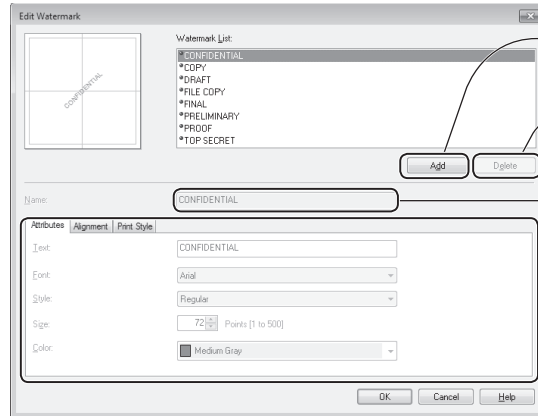

- Select to create a new watermark.
- Delete the selected watermark from the list.
- Enter the created watermark name.
- Specify watermark options.

- 5 Click [OK] to return to the Print window.
- 6 Click [OK] to start printing.



You can register up to 50 new watermarks, in addition to the provided watermarks.

View and Cancel Print Jobs

You can view or cancel print jobs that are waiting or in progress.

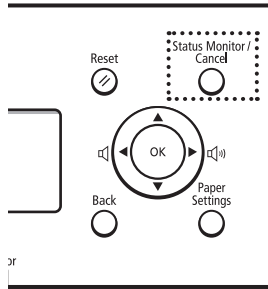

- 1 Press [○] (Status Monitor/Cancel).
- 2 Press [▲] or [▼] to highlight <Print Job Status>, and then press [OK].
- 3 View the details of a print job or cancel the job.
 - Press [▲] or [▼] to view the print job status.
 - Press [OK] to view the detailed information.
 - To cancel the job, press [▲] or [▼] to highlight <Cancel>, and then press [OK].

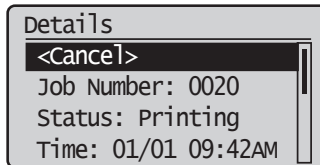

- 4 Press [○] (Status Monitor/Cancel) to close the screen.

Scan

This chapter describes the basic scan functions.

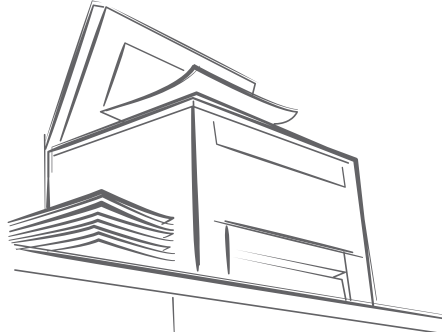

FAQs ? (→ p.69)
You can see frequently asked questions about the scan function.

Understand the Scanning Method.....	44
Scan a Document with the Operation Panel	45
Scan a Document with the MF Toolbox	46
Configuring Scan Settings Using the MF Toolbox	48
Scan a Document with the Scanner Driver	50

Understand the Scanning Method

Various scanning methods are provided.

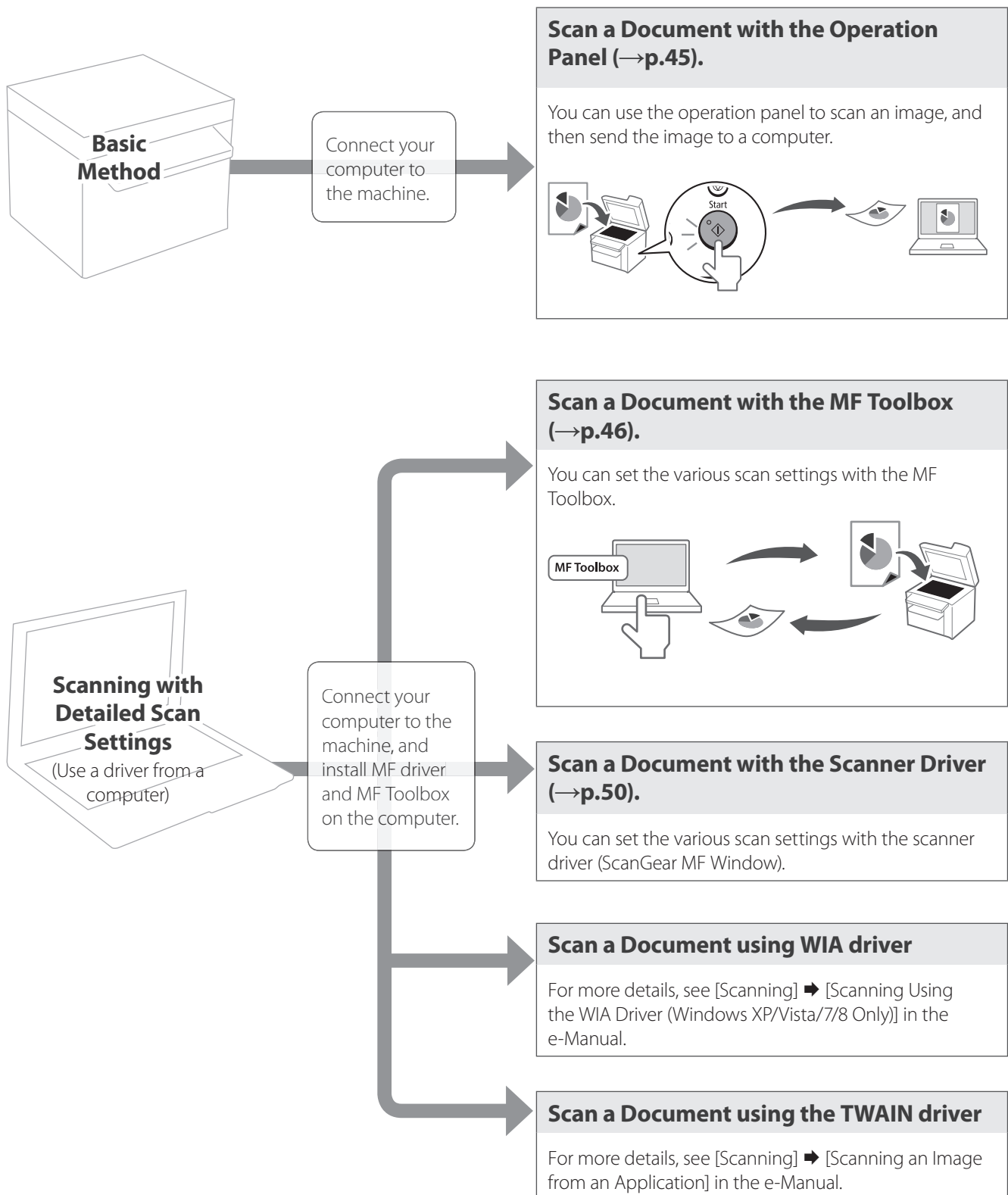

Scan a Document with the Operation Panel

You can scan a document using the Scan mode.

- 1 Make sure that a computer and the machine are connected (See the Starter Guide).
- 2 Place your documents (→p.16).

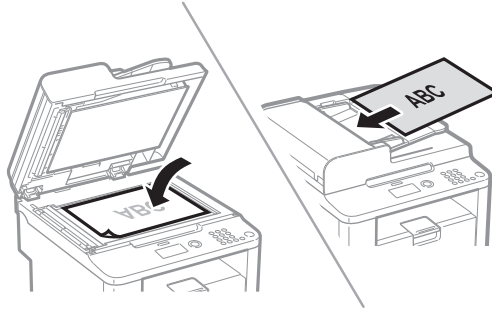

* D530 is not equipped with the feeder.

- 3 Switch to the Scan mode (→p.13).
- 4 Press [▲] or [▼] to highlight <Computer>, and then press [OK].

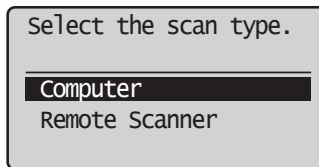

- 5 Press [▲] or [▼] to specify a destination, and then press [OK].

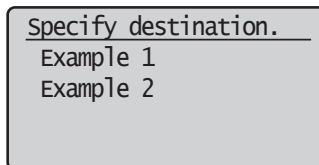

- 6 Press [▲] or [▼] to specify the scan settings.

<Color Scan>	<ul style="list-style-type: none">• Scan the document in color (300 dpi), and then save as a PDF file.• PDF settings: Searchable/Compact
<B&W Scan>	Scan the document in black and white (300 dpi), and then save as a TIFF file.
<Custom 1>	Scan the document in color (300 dpi), and then save as a JPEG/Exif file.
<Custom 2>	<ul style="list-style-type: none">• Scan the document in color (300 dpi), and then save as a PDF file.• PDF settings: Searchable/Standard

7 Press [OK] to start scanning.

When placing your documents in the feeder

Scanning operation starts.

When placing your documents on the platen glass

1. To continuously scan the document, press [▲] or [▼] to highlight <Scan Next Original>, and then press [OK].
2. press [▲] or [▼] to highlight <Store and Finish>, and then press [OK].

- When scanning is complete, the folder that contains the scanned images is opened on the screen of the computer.

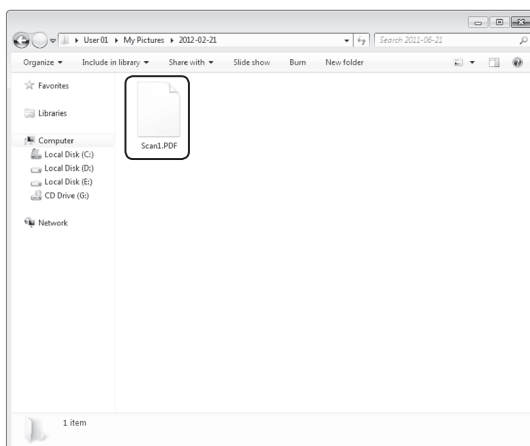

Canceling Scan Jobs

Press [⏹] (Stop) twice.

- * It is valid when only one job is processing or waiting.

Default Folder for Saving Scanned Images

By default, a new folder named after the date you scanned is created in the [Pictures] folder. (For Windows XP, the folder is created in the [My Pictures] folder in [My Documents].)

Scan a Document with the MF Toolbox

You can specify various scan settings if you select <Remote Scanner> from the operation panel, and then open the MF Toolbox.

- 1 **Make sure that a computer and the machine are connected properly, and the MF Toolbox is installed on the computer (See the Starter Guide).**
- 2 **Place your documents (→p.16).**
 - Use the platen glass for a higher scan quality.
- 3 **Switch to the Scan mode (→p.13).**



4 Press [▲] or [▼] to highlight <Remote Scanner>, and then press [OK].

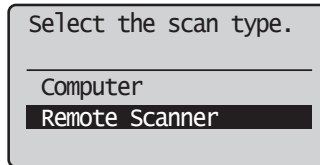

5 From your computer, double-click the [Canon MF Toolbox 4.9] icon.



6 When the MF Toolbox appears, click the desired scan mode button.

[Mail]	<ul style="list-style-type: none">• The scan preset for an e-mail attachment is displayed.• The scanned document will be attached to a new message in your e-mail application.
[OCR]	<ul style="list-style-type: none">• The scan preset for the OCR (Optical Character Reader) is displayed.• The scanned document will be read by your OCR software.
[Save]	<ul style="list-style-type: none">• The scan preset for a high quality scanning is displayed.• The scanned document will be saved in the default folder or in a destination that you specify.
[PDF]	<ul style="list-style-type: none">• The scan preset for the multiple page searchable PDF is displayed.• The scanned document will be saved as a PDF file.
[Color Scan] [B&W Scan] [Custom 1] [Custom 2]	<ul style="list-style-type: none">• The custom setting is displayed.• The scanned document will be saved in a destination.

7 When the scan setting window appears, specify the scan settings as needed (→p.48).

8 Click [OK] to start scanning.

- When scanning is complete, the folder in which the scanned document is saved is opened automatically.
- The scanned document will be opened in the registered application.

9 When scanning is complete, click [X] to close the MF Toolbox.

Configuring Scan Settings Using the MF Toolbox

This section describes the layout and features of each setting dialog box of the MF Toolbox.



For more details, see [Scanning] → [Using the MF Toolbox] in the e-Manual.

- Set the location of a document to be scanned.
- [Auto Mode] that detects the source automatically is recommended.

Set the size of the document to be scanned.

- Set the color mode.
- This setting is not available when scanning using the [Color Scan] or [B&W Scan] button.

- Set the size limit of attached files.
- This setting is available only when scanning using the [Mail] button.

- Set the scanning resolution.
- If you select a higher resolution, the image quality becomes higher, and the file size becomes bigger.

- Set the file name, file type, and location to be saved for the scanned image.
- Manually set the location to save the scanned image by clicking [Browse].
- Select to specify the format or location to save the scanned image after scanning.

Example: When [Mail] or [PDF] menu is selected in MF Toolbox

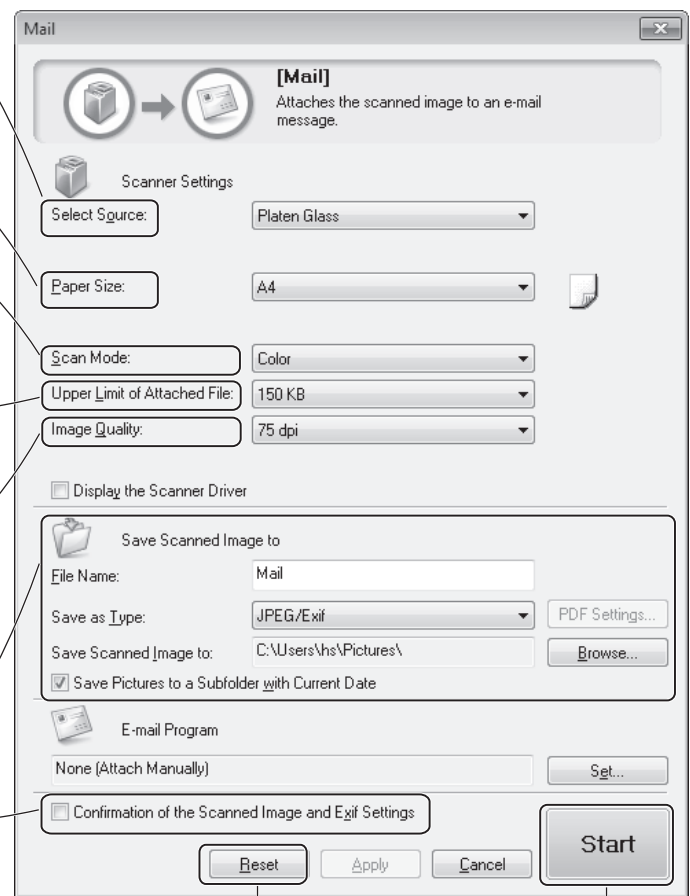

Reset the configured settings to the default values.

Scanning starts.

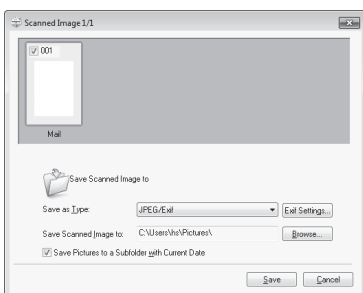

- Select to specify the scan settings using the scanner driver (→p.50).
- When **[Start]** is clicked with this check box selected, the [ScanGear MF] dialog box appears.
- This check box is not available when you scan using the **[OCR]** button.

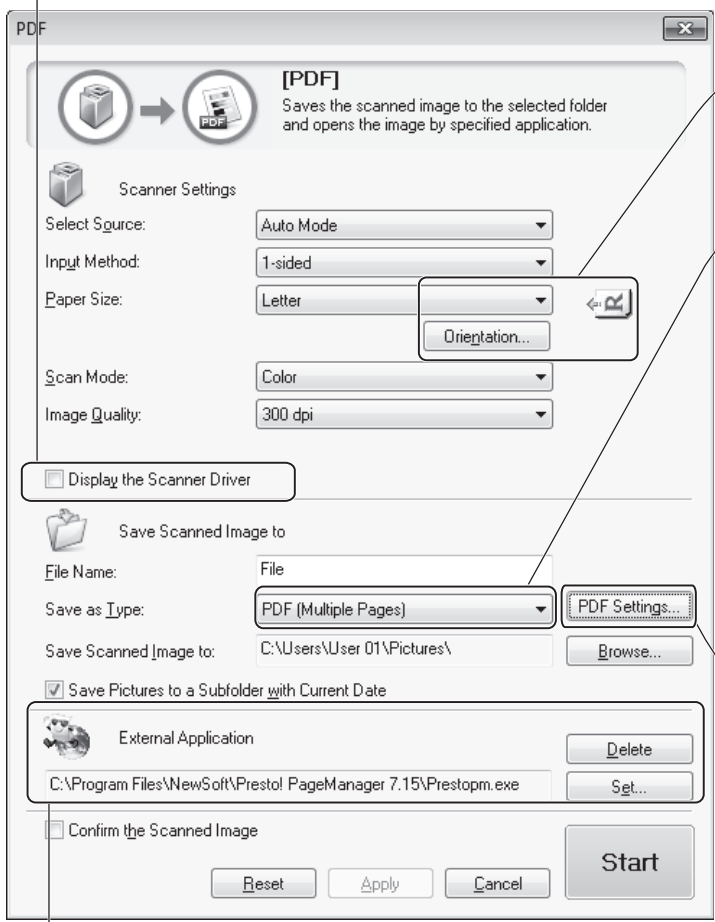

Set the orientation of the document.

Set the PDF file type to save the scanned image.

PDF (Single Page)	Creates a single-page PDF file.
PDF (Multiple Pages)	Save all scanned images as a single PDF file.
PDF (Add Pages)	<ul style="list-style-type: none"> • Add the scanned image to the last page of an existing PDF file. • Click [Browse] on [Save Scanned Image to] to select a PDF file to add.

If you selected PDF as the file type, you can create a searchable PDF. Also, you can set the compression ratio.

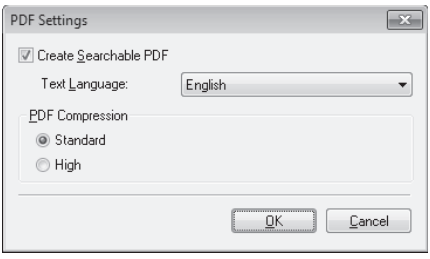

- Set an application to display the scanned image.
- Click **[Set]** to select an application or drag and drop the application icon.
- Click **[Delete]** to save the file without using the applications.

Scan a Document with the Scanner Driver

If you use the scanner driver window (ScanGear MF Window), you can use various features and scan only the necessary part with the preview function.

- 1 Make sure that a computer and the machine are connected properly, and the MF Toolbox is installed on the computer (See the Starter Guide).
- 2 Place your documents (→p.16).
- 3 Switch to the Scan mode (→p.13).
- 4 Press [▲] or [▼] to highlight <Remote Scanner>, and then press [OK].
- 5 From your computer, double-click the [Canon MF Toolbox 4.9] icon.
- 6 When the MF Toolbox appears, click the desired scan mode button.
 - You may not use the ScanGear MF when using the [OCR] mode.
- 7 When the scan setting window appears, select the [Display the Scanner Driver] check box, and then click [Start].
- 8 Select [Preview] on the scanner driver dialog box, and then specify settings as needed.

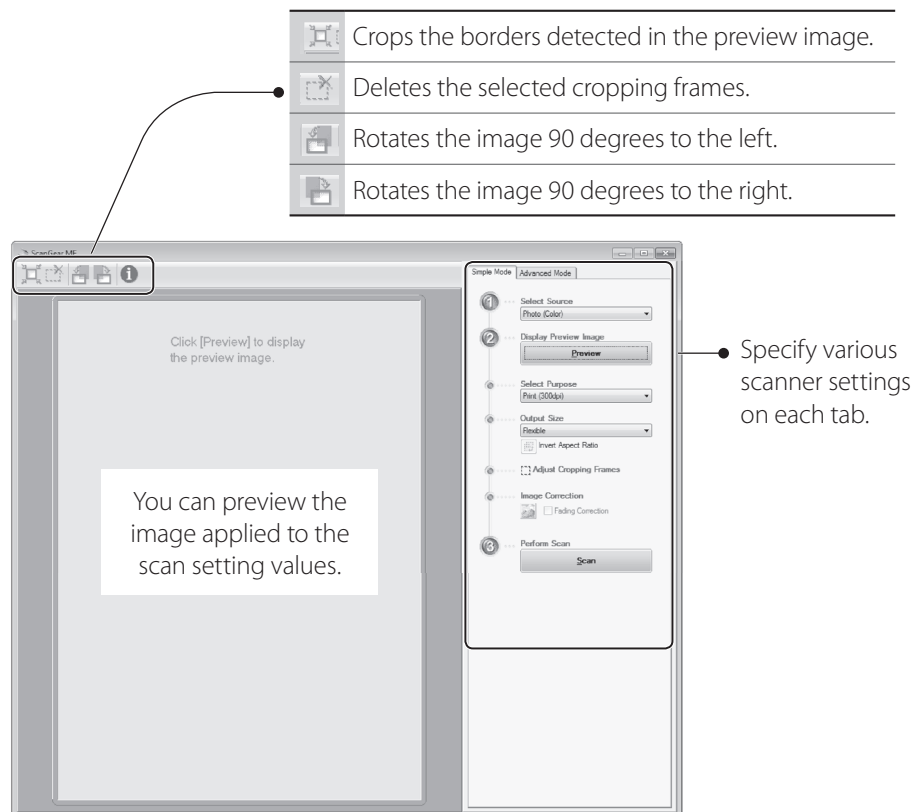

- 9 Click [Scan] to start scanning.
 - When scanning is complete, the folder in which the scanned document is saved opens automatically.
 - If an application is specified, the scanned document will be opened in the application.

10 When scanning is complete, click [X] to close the MF Toolbox.

Maintenance and Management

This chapter describes how to clean the machine, replace the toner cartridge, and explains the report and list function used for managing the machine.

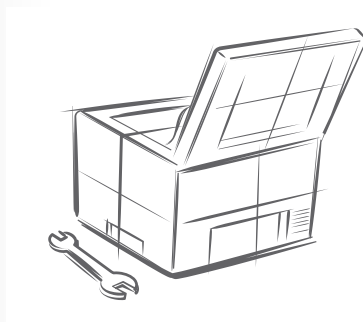

Clean the Machine	52
Cleaning the Exterior and Interior	52
Cleaning the Fixing Unit	53
Cleaning the Platen Glass and Feeder	54
Check and Replace Toner Cartridges	55
Conserving the Toner to Extend the Life of Toner Cartridges.....	55
Replacing the Toner Cartridge	56
Manage Using the List Function	58

Clean the Machine

Clean the exterior and interior of the machine, platen glass, feeder, and the fixing unit periodically.

Cleaning the Exterior and Interior

Clean the exterior and interior of the machine to prevent toner powder and paper dust from accumulating inside.



For safety, be sure to turn OFF the machine and disconnect all cables from the machine before cleaning the machine. When you finish cleaning the machine, wait for it to dry completely before reconnecting the power cord, and then turn ON the power.

Cleaning the Exterior

- 1 Turn OFF the machine and disconnect all the cables from the machine.
- 2 Remove any documents from the platen glass or feeder.
- 3 Clean the exterior of the machine and ventilation slots with a soft, well wrung-out cloth dampened with water or a mild detergent that has been diluted with water.

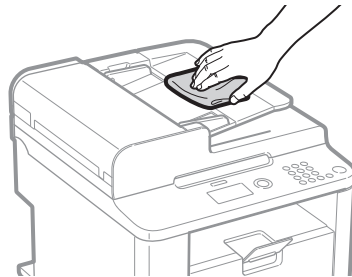

- 4 Wait for the printer to dry completely.
- 5 Reconnect all the cables, and then turn ON the power.

Cleaning the Interior

- 1 Turn OFF the machine and disconnect all the cables from the machine.
- 2 Remove any documents from the platen glass or feeder.
- 3 Lift the scanning platform, open the toner cover, and then remove the toner cartridge.



- 4 Remove any toner or paper debris from the interior of the machine, with a soft, dry cloth that is clean and lint-free.

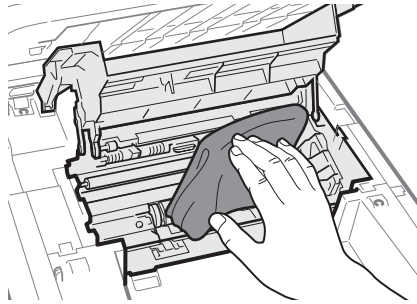

- 5 Insert the toner cartridge.
- 6 Close the toner cover, and then lower the scanning platform.
- 7 Reconnect all the cables, and then turn ON the power.

 **CAUTION**

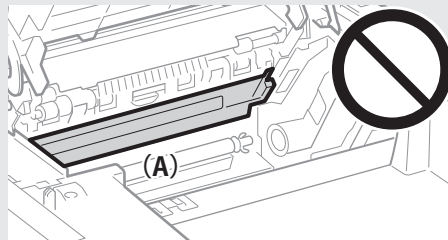

When closing the scanning platform:

Be careful not to get your fingers caught.

Do not touch the fixing unit (A).





Touching the fixing unit (A) may cause burns as it becomes very hot during use.

If you get toner on your hands or clothing:

If toner gets on your hands or clothing, wash them immediately with cold water. Washing with warm water makes it impossible to remove the toner stains.

Cleaning the Fixing Unit

Clean the fixing unit when black streaks appear on printed pages.

- 1 Press [] or [] to highlight <Adjustment/Maintenance>, and then press [OK].
- 3 Press [] or [] to highlight <Clean Fixing Unit>, and then press [OK].
- 4 Load Letter size plain paper in the multi-purpose tray, and then press [OK].
 - The cleaning process begins. Cleaning takes approximately 90 seconds.
- 5 When the cleaning is complete, press [] (Menu) to close the screen.

Cleaning the Platen Glass and Feeder

If a scanned image has unexpected specks, clean the platen glass and feeder.

Cleaning the Platen Glass

- 1 Turn OFF the machine and disconnect all the cables from the machine.
- 2 Remove any documents from the platen glass.
- 3 Open the feeder or the platen glass cover.
- 4 Clean the platen glass and the under surface of the feeder.
 - Clean the platen glass with a well wrung out cloth dampened with water and wipe it with a soft, dry cloth.

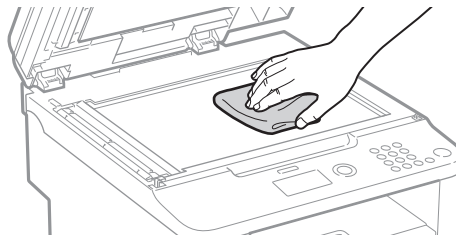

- 5 Close the feeder or the platen glass cover.
- 6 Reconnect all the cables, and then turn ON the power.

Cleaning the Feeder

- 1 Turn OFF the machine and disconnect all the cables from the machine.
- 2 Remove any documents from the feeder.
- 3 Open the feeder cover, clean the rollers with a well wrung-out cloth dampened with water, and then wipe them with a soft and dry cloth.

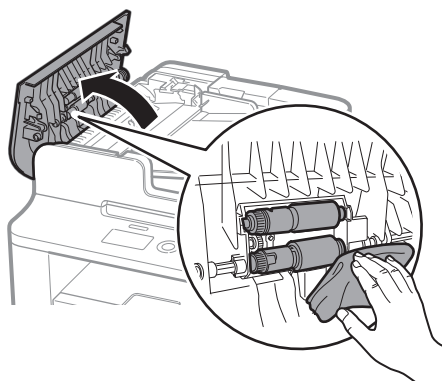

- 4 Close the feeder cover.
- 5 Reconnect all the cables, and then turn ON the power.



Check and Replace Toner Cartridges

Toner cartridges are consumable products. When the toner has almost run out, streaks may appear on printed pages. Replace the toner cartridge if necessary.

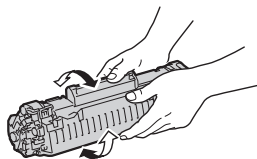
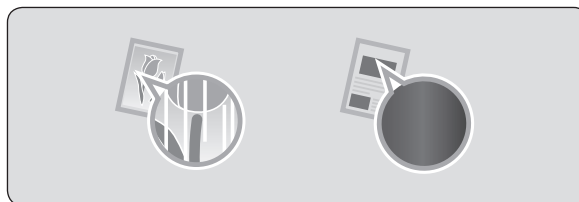

Gently shake the toner cartridge 5-6 times to evenly distribute the toner (→p.55).

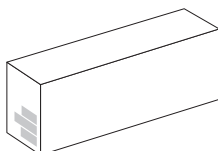

If the print result is not improved, replace the toner cartridge (→p.56).

Conserving the Toner to Extend the Life of Toner Cartridges

If you redistribute the toner, you may be able to print for some time until the toner runs out.

- 1 Lift the scanning platform, open the toner cover, and then remove the toner cartridge.

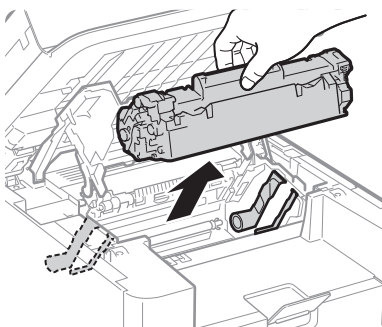

- 2 Gently shake the toner cartridge 5-6 times to evenly distribute the toner.

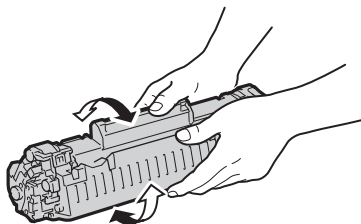

CAUTION

If toner comes in contact with your hands or clothing, wash them immediately in cold water. Do not use warm water, as it will set the toner and make it difficult to remove the toner stains.

3 Insert the toner cartridge.

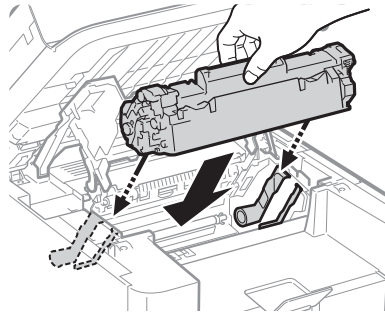

4 Close the toner cover, and then lower the scanning platform.

Replacing the Toner Cartridge

You can purchase replacement toner cartridges from your local authorized Canon dealer.

NOTE

Supported Canon Genuine Toner Cartridge:
Canon Cartridge 128

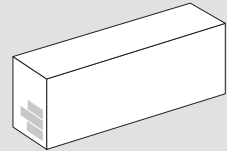

1 Open the operation panel and the toner cover, and then remove the toner cartridge.

2 Prepare a new toner cartridge.

- Store the protective bag. It is required when you remove the toner cartridge for printer maintenance or other purposes.



Shake the toner cartridge 5-6 times to evenly distribute the toner.

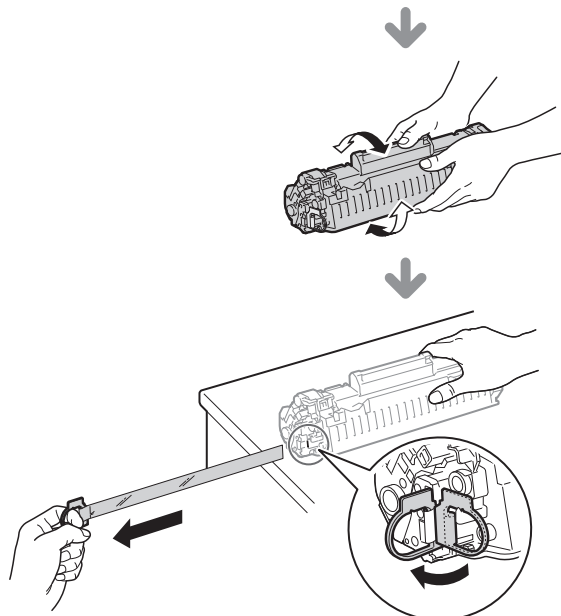

Place the toner cartridge on a flat surface, remove the tab, and carefully pull the sealing tape completely out (20" (50 cm)).



When pulling out the sealing tape:

- Do not pull the sealing tape at an angle or up and down. If the tape breaks, it may not be pulled out completely.

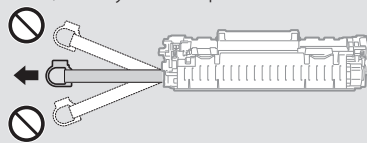

- Even if the sealing tape stops at midpoint, pull it out of the toner cartridge completely.
- If any tape remains in the toner cartridge, this may result in poor print quality.

Disposing of the removed sealing tape:

Dispose of the packing materials according to local regulations.

3 Insert the toner cartridge.

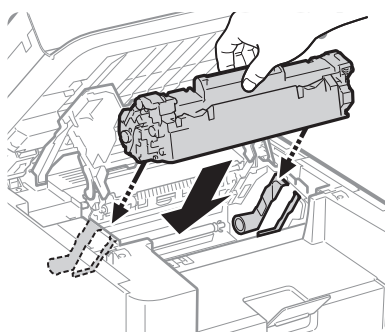

4 Close the toner cover, and then lower the scanning platform.

WARNING

Do not dispose of a used toner cartridge in open flames.

This may cause the toner remaining inside the cartridge to ignite, resulting in burns or a fire.

When cleaning up spilled or scattered toner:

If you accidentally spill or scatter toner, carefully gather the toner particles together or wipe them up with a soft, damp cloth in a way that prevents inhalation. Never use a vacuum cleaner to clean up spilled toner. Doing so may cause a malfunction in the vacuum cleaner, or result in a dust explosion due to static discharge.

CAUTION

Precautions to take when you get toner onto your hands or into clothing:

If toner comes in contact with your hands or clothing, wash them immediately in cold water. Do not use warm water, as it will set the toner and make it difficult to remove the toner stains.

Do not allow the toner to scatter.

Do not pull out the sealing tape forcefully or stop before it is removed, as this may cause toner to spill out. If toner gets into your eyes or mouth, flush them immediately with cold water and immediately consult a physician.

NOTE

- Follow all local and federal regulations when disposing of the sealing tape removed from the new toner cartridge.
- Canon will collect and recycle your used toner cartridges (→p.71).

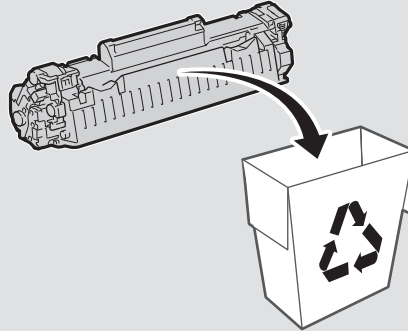

- For more details about handling toner cartridges, see [Handling Toner Cartridges] in the e-Manual.

Manage Using the List Function

Print out lists to view information about the machine and settings.

- 1 Press [○] (Report).
- 2 Press [▲] or [▼] to highlight <Print Report Lists>, and then press [OK].
- 3 Press [▲] or [▼] to highlight <User Data List>, and then press [OK].
- 4 Follow the on-screen instructions to print the report or list.
- 5 Press [○] (Report) to close the screen.

NOTE

Report and list printouts are limited to 10 pages.

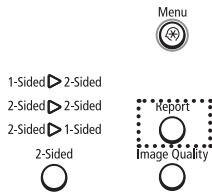

Troubleshooting

This chapter describes how to clear paper jams and offers solutions to problems you may be having.



Clear Jams	60
Clearing Document Jams in the Feeder (D560 Only)	61
Clearing Paper Jams Inside the Machine	62
Resolve a Displayed Message	65
Resolve an Error Code	65
Improve Output Quality	66
Resolve a Problem	68

Clear Jams

When **<Paper jam.>** appears on the display, a paper jam has occurred in the feeder or inside the machine. To remove the jammed document or paper, follow the instructions on the display.

⚠ Paper jam.
Press [▶] to display steps. ▶

⚠ WARNING

When removing jammed documents or paper:

Use caution to avoid paper cuts.

When removing jammed paper or inspecting the inside of the machine:

Do not allow necklaces, bracelets, or other metal objects to touch the inside of the machine, as this may result in burns or electrical shock.

⚠ CAUTION

If loose toner comes into contact with your skin or clothing:

Wash with cold water. Do not wash with warm water, as this will set the toner and cause it to stain your skin or clothing.

When removing jammed documents or paper:

If paper is jammed, remove it carefully so that no pieces of paper remain inside the machine according to the displayed message. Also, do not put your hand in an area other than indicated areas, as this may result in personal injuries or burns.



If the jammed paper is torn:

Remove all torn pieces to avoid further jams.

If repeated paper jams occur:

Do the following:

- Make sure that the following packing material is completely removed.

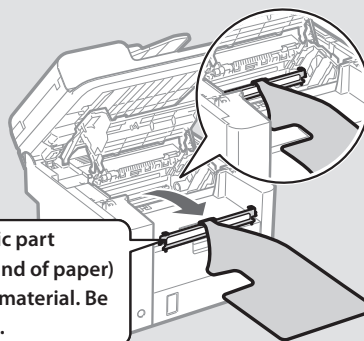

This part (a plastic part attached to the end of paper) is also a packing material. Be sure to remove it.

- Fan the paper stack and tap the edge on a flat surface to align the paper before loading it into the machine.
- Make sure that the paper meets the requirements for use (→ p.19).
- Make sure that you have removed all scraps of paper from the inside of the machine.



Clearing Document Jams in the Feeder (D560 Only)

After removing any documents placed in the feeder, follow the procedure below to remove jammed documents.

- 1 Open the feeder cover and lift the lock release lever.

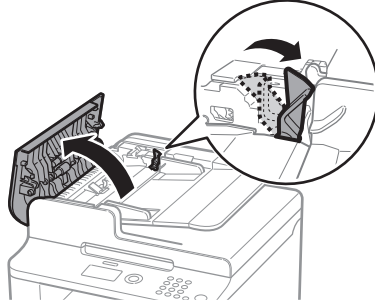

- 2 Remove any jammed document by pulling it gently.

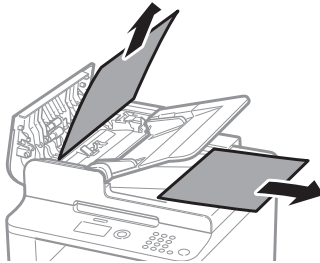

- 3 Hold the green grip, and then open the inner cover.

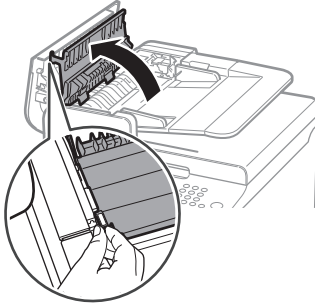

- 4 Remove any jammed document by pulling it gently.

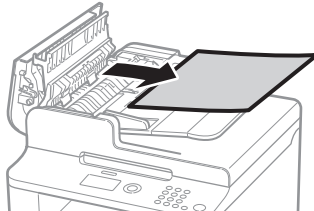

- 5 Close the inner cover.
- 6 Replace the release lever and close the feeder cover.
- 7 Place documents in the feeder.

Clearing Paper Jams Inside the Machine

Follow the procedure below to remove jammed paper.

Step 1 Check and remove the jammed paper inside the machine.

- 1 Lift the scanning platform, and then open the toner cover.
- 2 Remove the toner cartridge.

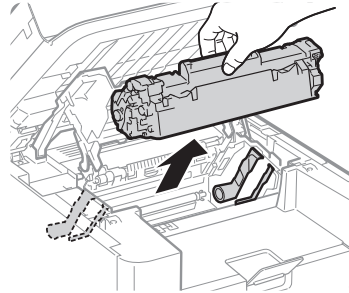

- 3 Remove any jammed paper by pulling it gently.

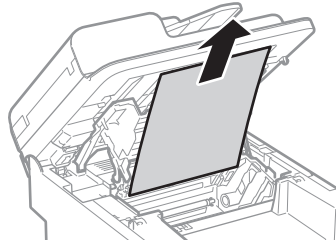

- 4 Push up the green colored part (A), and then pull the paper exit guide (B) to open.

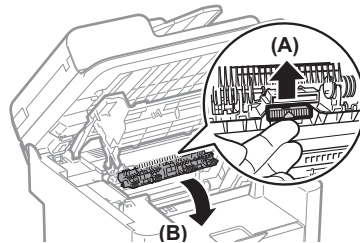

- 5 Remove any jammed paper by pulling it gently.

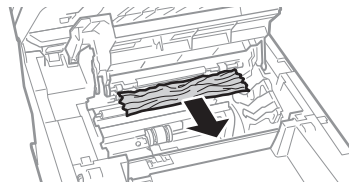

- 6 Lift the paper exit guide, and then firmly close it.
 - Ensure that each end of the paper exit guide is closed.

- 7 Gently pull any jammed paper downward from between the fixing unit (A) and roller (B) until the leading edge emerges from the machine.

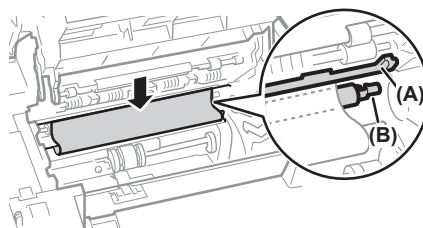

- 8 When the leading edge emerges, hold both sides of the jammed paper and carefully pull it out.

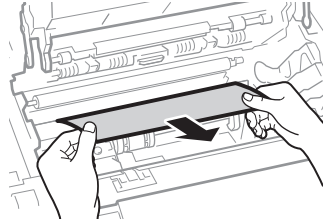

Step 2 Check and remove the jammed paper in the paper cassette.

- 1 Open the front cover and lower front cover.

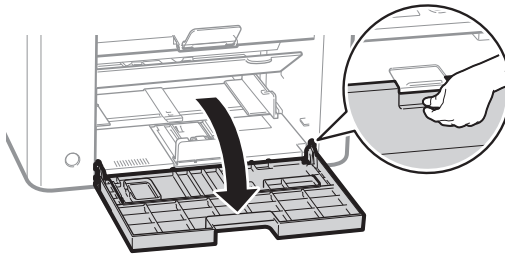

- 2 Remove any paper in the multi-purpose tray.

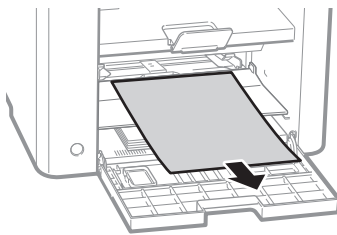

- 3 Pull up the multi-purpose tray, and then remove any paper loaded in the paper cassette.

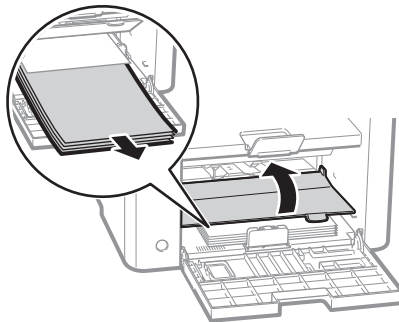

- 4 Remove any jammed paper by pulling it gently.

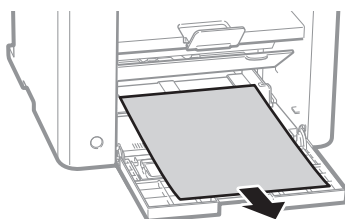

- 5 Reload paper into the paper cassette and close the front cover and lower front cover.

Step 3 Check and remove the jammed paper in the rear cover.

1 Open the rear cover.

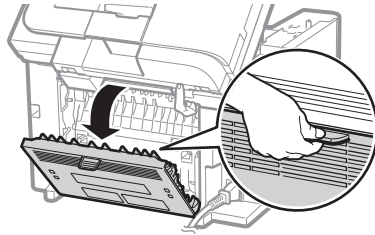

2 Remove any jammed paper by pulling it gently.

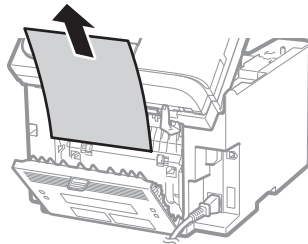

3 Close the rear cover.

Step 4 Lower the scanning platform and restore to a printable condition.

1 Insert the toner cartridge.

2 Close the toner cover and lower the scanning platform.

CAUTION

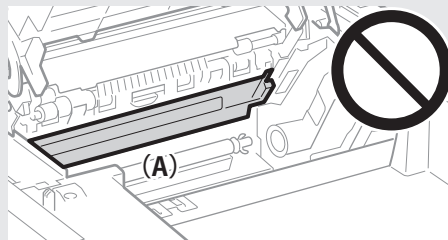

Do not touch the fixing unit (A).

Touching the fixing unit (A) may cause burns as it becomes very hot during use.

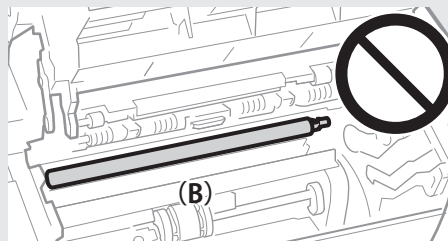

Do not touch the transfer roller (B).

Touching the transfer roller may damage the machine.



Resolve a Displayed Message

This section describes some of messages related to the memory and paper.



For more details about other messages, see [**Troubleshooting**] → [**Onscreen Messages**] in the e-Manual.

Message	Action
<Memory is full. Scanning canceled. Print?>	<ul style="list-style-type: none"> • Print pages successfully scanned or cancel the job. • Split the job into smaller subsets or change the <Original Type>. Change the document type in <Photo → ... → Text> order.
<Incorrect Size/Setting>	<ul style="list-style-type: none"> • Change the <Paper Settings> to the size of the loaded paper (→p.22). • When printing with the printer driver, verify that the paper size setting on the computer is correct.
<No Paper: Drawer 1> <No Paper: MP Tray>	Load paper same as the paper type displayed on the screen (→p.22).

Resolve an Error Code





If an error occurs, a report that contains a 3-digit error code is printed. Locate the error code in the table and follow the recommended actions to resolve the problem.







Error Code	Cause	Action
#001	A document jam has occurred.	Remove the jammed document.
#037	The machine's memory is full.	Print or delete any documents stored in memory.
	The data size exceeds the machine's available memory.	Reduce the data resolution or change the file format to reduce the data size.

Improve Output Quality

Follow the recommended actions for each symptom to improve the output quality.

NOTE If you cannot solve the problem with the following actions, see [Troubleshooting] → [Printing Results Are Not Good] in the e-Manual.

Symptom	Example	Action
Paper curls.		<ul style="list-style-type: none"> • Verify that the appropriate paper is being used (→p.19). • Print a test page with new paper. • Verify that the paper is loaded properly (→p.19). • Change the <Special Mode V> setting from the operation panel.
Paper creases.		<ul style="list-style-type: none"> • Verify that the appropriate paper is being used (→p.19). • Print a test page with new paper. • Verify that the paper is loaded properly (→p.19). • Remove any foreign objects inside the machine. • Change the <Special Mode V> setting from the operation panel.
Printing is uneven.		<ul style="list-style-type: none"> • Verify that the appropriate paper is being used (→p.19). • Print a test page with new paper. • Verify that the paper is loaded properly (→p.19). • Change the <Special Mode J> setting from the operation panel.
White specks appear.		<ul style="list-style-type: none"> • Verify that the appropriate paper is being used (→p.19). • Print a test page with new paper. • If printing high-contrast documents from a computer, open the printer driver and select [Finishing] → [Advanced Settings] → [Special Print Mode] → [Special Settings 2] to adjust the density.
The toner adheres to your hand.		<ul style="list-style-type: none"> • Verify that the appropriate paper is being used (→p.19). • Print a test page with new paper. • Change the <Special Mode K> setting from the operation panel.

Symptom	Example	Action
The printed paper has vertical streaks.		<ul style="list-style-type: none"> • Verify that the appropriate paper is being used (→p.19). • Print a test page with new paper. • If the machine is not in use for a long time after the toner cartridge has been replaced, change the <Special Mode B> settings from the operation panel. • When copying, change the <Special Mode Z> and <Special Mode D> settings from the operation panel. • When printing from a computer, change the <Special Mode D> settings from the operation panel, or change the [Special Print Adjustment] settings from the printer driver.
Smudge marks of spattering toner appear around the text or as patterns.		<ul style="list-style-type: none"> • Verify that the appropriate paper is being used (→p.19). • Print a test page with new paper. • Change the <Special Mode U> settings from the operation panel.
The overall print result is dark.		<ul style="list-style-type: none"> • Adjust the copy density settings (→p.29). • If the machine is exposed to direct sunlight or strong light, move the machine to another location.
The bottom edge of paper has smudge marks.		Provide a margin around the data.
A portion of the page is not printed.		Provide a margin around the data.
Printed bar codes cannot be scanned.		If printing a bar code from a computer, open the printer driver and select [Finishing] ➔ [Advanced Settings] ➔ [Special Print Mode] ➔ [Special Settings 1] to change the printing preferences.

Resolve a Problem

Follow the procedures below to resolve your problem.

WARNING

If the machine makes strange noises or emits smoke or odors:

Turn OFF the power immediately, disconnect the power cord, and contact the Canon Customer Care Center. Do not attempt to disassemble or repair the machine yourself.



If you attempt to repair the machine by yourself, it may void the limited warranty.

Check 1 Verify that the cables are connected properly and that the power is switched ON (See the Starter Guide.)

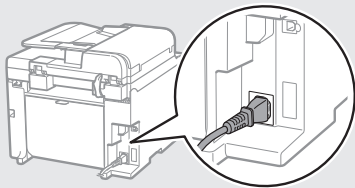

Check 2 Verify that the machine is not in Sleep mode (→ p.24).

- If the [Energy Saver] key blinks, press it to exit the Sleep mode.

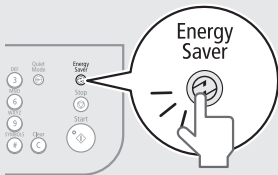

Check 3 Press [Status Monitor/Cancel] to check the status of the machine.

- If there are jobs in process, wait until the jobs are finished.

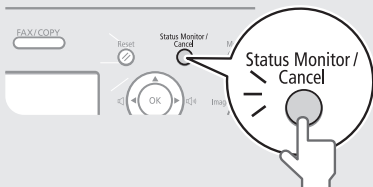

Check 4 Verify that the Error indicator is not on or blinking.

- Make sure that paper is loaded properly (→p.19).
- Remove any jammed paper (→p.60).
- Turn OFF the power, wait for more than 10 seconds, and then turn it ON again.

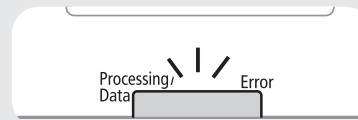

Check 5 Verify that no message appears on the display.

- If a message appears, resolve the problem (→p.65).

If you cannot solve the problem

See [Troubleshooting] in the e-Manual or the Q&A from the support page of the official Canon Web site.

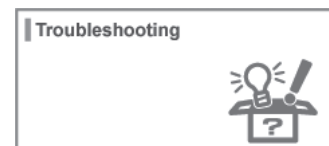

If you cannot solve the problem

Contact your local authorized Canon dealer or the Canon help line for assistance.



Please have the following information ready when you contact Canon.

- Product name
- Serial number
- Place of purchase
- Nature of problem
- Steps you have taken to solve the problem and the results



Can I use the scan function when using a machine and drivers that are shared by another person?

A

No, you may not use the scan function when sharing drivers that are installed to another computer. To use the scan function, install the MF Drivers on your computer.

You can use the supplied user software CD-ROM or download the drivers from the official Canon Web site (<http://www.usa.canon.com>).

For details about installing drivers, see the Starter Guide.



To which file formats can I save the scanned images?

A

You may save scanned files to the following formats:

- BMP
- JPEG/Exif
- TIFF
- PDF

When saving as a PDF file, you can create a PDF file of a single or multiple page document, or add a page to an existing PDF file.



Can I change the folder that the scanned images are saved to?

A

Yes, you can change the folder to save the scanned images when scanning with the MF Toolbox.

To change,

1. From the MF Toolbox screen, click [**Browse**].

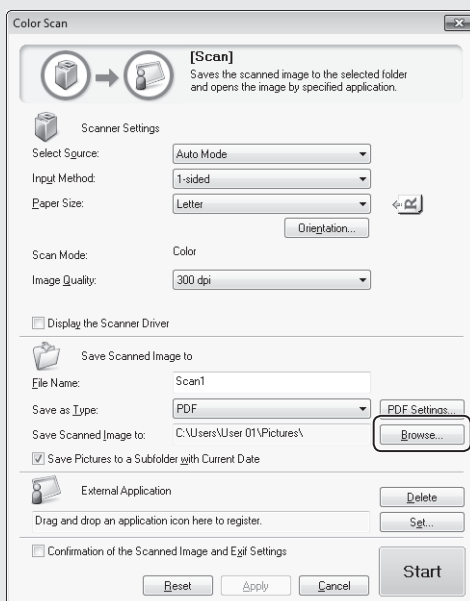

2. Locate a folder to save the scanned images, and then click [**OK**].

LA

Yes, you can save multiple images as a single PDF file when scanning with the MF Toolbox.

To make a single PDF file of multiple pages,

1. From the PDF mode screen of MF Toolbox, select **[PDF (Multiple Pages)]** in **[Save as Type]**.

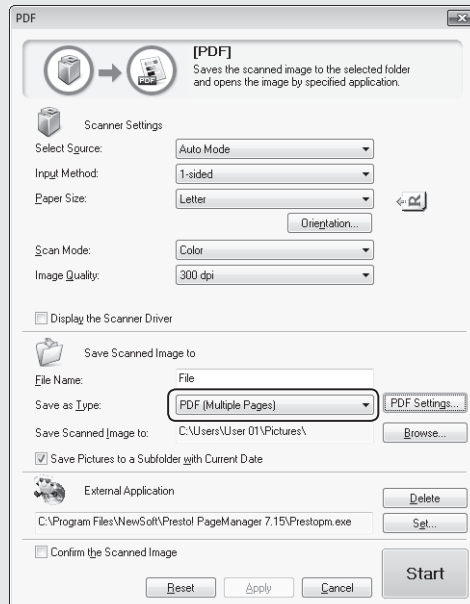

2. Scan the documents.

Recycling Used Cartridges



Canon has instituted a worldwide recycling program for cartridges called "The Clean Earth Campaign". This program preserves precious natural resources by utilizing a variety of materials found in the used cartridges that are of no further use, to remanufacture new cartridges which, at the same time, keeps the environment cleaner by reducing landfill waste. Complete details concerning this program are enclosed in each Cartridge box.

The Clean Earth Campaign

THE Canon CARTRIDGE RECYCLING PROGRAM

The Canon Cartridge Recycling Program fulfills the first initiative of Canon's Clean Earth Campaign, which supports four critical environmental areas:

- Recycling in the Workplace
- Conserving Environmental Resources
- Scientific Research and Education
- Encouraging Outdoors Appreciation

The remaining "Clean Earth" initiatives are supported in the U.S. through sponsorships of the National Park Foundation, the National Wildlife Federation, and The Nature Conservancy and in Canada through donations to the World Wildlife Fund Canada and The Nature Conservancy of Canada.

Since its inception, The Canon Cartridge Recycling Program has collected huge amount of cartridges that otherwise would have been discarded into landfills or similar facilities.

Instead, this rapidly growing program returns used cartridges to the manufacturing process, thus conserving an array of resources. Becoming a part of this worthwhile program is easy. When your cartridge is of no further use, simply follow the instructions detailed for U.S. or Canadian residents.

We appreciate your support of The Canon Cartridge Recycling Program.

Working together we can make a significant contribution to a cleaner planet.

- Cartridges collected through this program are not refilled.
- You are not entitled to a tax deduction or rebate for the return of empty cartridges.
- This program may be modified or discontinued without notice.

The Clean Earth Campaign

Supporting Environmental Initiatives With

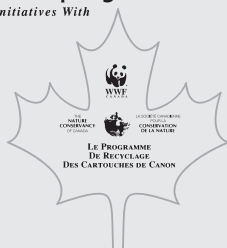

U.S.A. PROGRAM

Packaging

Option A-1: Single Box Return

- Repackage the empty cartridge utilizing the wrapper and pulp mould end-blocks from the new cartridge's box.
- Place the empty cartridge in the box of your new cartridge. Seal the box.

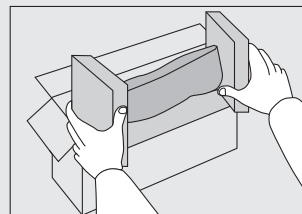

Option B: Volume Box Return

We encourage you to use this option as a more efficient way to ship cartridges.

- Place as many cartridges as possible into one box. Carefully seal the box with tape; or
- Call 1-800-OK-Canon to receive your free eight cartridge collection box.

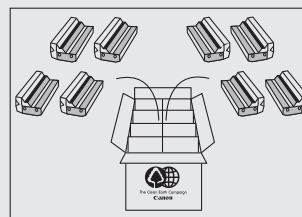

Option A-2: Multiple Box Return

We encourage you to use this option as a more efficient way to ship cartridges.

- Complete Option A-1.
- Bundle multiple cartridge boxes together securely with tape.

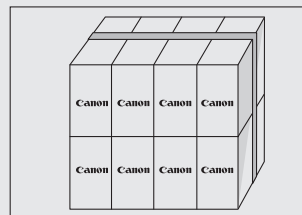

Please be sure that the shipment does not exceed UPS specifications.

Maximum weight = 70 lb. (31.8 kg)

Maximum length = 108" (2,743 mm)

Maximum girth (length + 2 x width + 2 x height) = 130" (3,302 mm)

.If your shipment exceeds the above limits, please call 1-800-OK-Canon for special shipping information.

Please Note:

Do not send defective cartridges for replacement. Defective cartridges under warranty should be exchanged by an authorized dealer or service facility as provided in the warranty.

Shipping

Apply the UPS authorized returning label provided in this guide. Residents of Alaska and Hawaii: Do not use the UPS authorized returning label. For Alaska and Hawaii Canon set up alternative mail service with the U.S. Postal Service.

Please call 1-800-OK-Canon to receive U.S. Postal Service merchandise returning label.

- Give the shipment to your UPS driver when you receive your next regular delivery; (UPS may charge a fee for customers who call UPS to pick up a cartridge shipment if they do not already have a delivery scheduled.)
or
- Take the shipment to your local UPS receiving point.



CANADA PROGRAM-CANADA PROGRAMME

Option A: Single Box Return

- Repackage the empty cartridge utilizing the wrapper and pulp mould end-blocks from the new cartridge's box.
- Place the empty cartridge in the box of your new cartridge. Seal the box.
- Apply the Canon Canada Inc./Canada Post label provided in this brochure. Canon's labels are specially marked so that Canon pays the postage.
- Deposit your empty cartridge in any full size street mailbox or take it to your local Canada Post outlet or franchise.

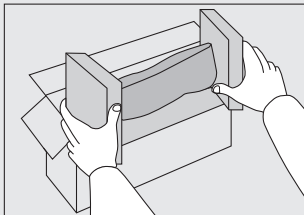

Option B: Volume Box Return (eight or more cartridges)

We encourage you to use this option as a more efficient way to ship cartridges.

- Call 1-800-667-2666 to receive your free Canon collection box kit.
- The collection box can accommodate eight individual cartridge boxes.
- Place your eight individually packaged boxes of empty cartridges into the Canon collection box. Seal the box.
- Apply the Canon Canada Inc./Canada Post label provided in this brochure.
- Canon's labels are specially marked so that Canon pays the postage.
- Deliver to any local Canada Post outlet or franchise. Customers who hold a Commercial pick-up agreement with Canada Post may have their collection box picked up.

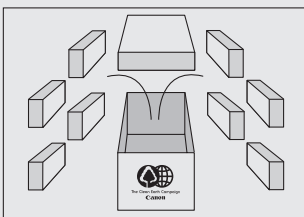

Working to preserve endangered species is a long-standing Canon interest.

To this end, for every cartridge collected, Canon Canada donates \$1, shared equally between World Wildlife Fund Canada and the Nature Conservancy of Canada. This donation is utilized in Canada.

- For further information about The Clean Earth Campaign in Canada, please call or write to Canon.
1-800-667-2666
Canon Canada Inc.
Corporate Customer Relations
6390 Dixie Road
Mississauga, ON L5T 1P7

Important Safety Instructions

Please read the "Important Safety Instructions" in this manual and in the e-Manual thoroughly before operating the machine.

As these instructions are intended to prevent injury to the user and other persons or to prevent destruction of property, always pay attention to these instructions and operational requirements. Please note that you are responsible for all damages caused by failure to follow the directions provided herein, using the device for any purpose for which it was not intended, or repairs or alterations made by anyone other than a Canon-approved technician.

Installation

! WARNING

- Do not install the machine near flammable substances, such as alcohol-based products or paint thinners. If these substances come into contact with the electrical parts inside the machine, they could ignite these substances and cause a fire or increase your risk of electric shock.
- Do not place necklaces and other metal objects or containers filled with liquid on the machine. If foreign substances come into contact with electrical parts inside the machine, this may result in a fire or electrical shock.
If any of these substances falls into the machine, turn OFF the power to the machine immediately and contact your local Canon dealer.

! CAUTION

- Do not install the machine in the following locations. Doing so may result in personal injury, fire, or electrical shock.
 - Unstable location
 - A location subject to excessive vibrations
 - A location that blocks the ventilation slots (too close to walls, bed, shaggy rug, and other similar objects)
 - A damp or dusty location
 - A location exposed to direct sunlight or an outside place
 - A location subject to high temperatures
 - A location near open flames
 - A location with poor ventilation
- Although ozone is produced by this machine when it is working, the amount is too low to have any effect on the human body. However, if you intend to use the machine for long periods of time, ensure that the installation location is well ventilated.
- Do not connect unapproved cables to this machine. Doing so may result in a fire or an electric shock.
- Machines with a hard disk may not operate properly when used at high altitudes of about 3,000 meters above sea level, or higher.

Power Supply

WARNING

- Do not use power cords other than the one provided, as this can result in a fire or electrical shock.
- Do not modify or bend the power cord and do not pull on it with great force. Do not place heavy objects on the power cord. Damaging the power cord may result in a fire or an electric shock.
- Do not plug or unplug the power plug with wet hands, as this can result in electrical shock.
- Do not use extension cords or multi-plug power strips with this machine. Doing so may result in a fire or electric shock.
- Do not bundle up or tie up the power cord in a knot, as this can result in a fire or electrical shock.
- Insert the power plug completely into the AC power outlet. Failure to do so can result in a fire or electrical shock.
- Remove the power plug completely from the power outlet during a thunder storm. Failure to do so can result in a fire, electrical shock, or malfunction.

CAUTION

- Use only a power supply that meets the voltage requirements listed herein. Failure to do so may result in a fire or electric shock.
- Do not obstruct the power outlet where this machine is connected, so that you can unplug the power cord easily in an emergency.

Handling

WARNING

- Do not disassemble or modify the machine. There are high-temperature and high-voltage components inside the machine which may result in a fire or electrical shock.
- Do not allow children to touch or play with the power cord and cables or internal or electrical parts. Doing so may result in serious personal injury.
- Please contact an authorized Canon dealer if the machine makes an unusual noise, emits an unusual smell, or emits smoke or excessive heat. Continued use may result in a fire or electric shock.
- Do not use flammable sprays near the machine. If flammable substances come into contact with electrical parts inside the machine, this may result in a fire or electric shock.

CAUTION

- For your safety, please unplug the power cord if the machine will not be used for a long period of time.
- Use caution when opening and closing covers to avoid injury to your hands.
- Keep hands and clothing away from the rollers in the output area. If the rollers catch your hands or clothing, this may result in personal injury.
- The inside of the machine and the output slot is very hot during and immediately after use. Avoid contact with these areas to prevent burns. Also, printed paper may be hot immediately after being output, so use caution when handling it. Failure to do so may result in burns.

Maintenance and Inspections

WARNING

- Turn OFF the machine and unplug the power cord from the outlet before cleaning. Failure to do so may result in a fire or an electric shock
- Unplug the power plug from the power outlet periodically and clean the area around the base of the power plug's metal pins and the power outlet with a dry cloth to remove dust and grime. When damp, accumulated dust may cause short circuiting or fires.
- Use a damp, well wrung-out cloth to clean the machine. Dampen cleaning cloths with water only. Do not use alcohol, benzenes, paint thinners, or other flammable substances. If these substances come into contact with electrical parts inside the machine, this may result in a fire or electric shock.
- Check the power cord and plug regularly for damage. Check the machine for rust, dents, scratches, cracks, or excessive heat generation. Use of poorly-maintained equipment may result in a fire or electric shock.

Consumables

WARNING

- Do not dispose of used toner cartridges in open flames. This may cause an ignition, and result in burns or a fire.
- If you accidentally spill or scatter toner, carefully wipe up the loose toner with a damp, soft cloth and avoid inhaling any toner dust. Never use a vacuum cleaner to clean up loose toner. Doing so may cause a malfunction in the vacuum cleaner or result in a dust explosion due to static discharge.

CAUTION

- Keep the toner cartridges and other consumables out of the reach of small children. If toner is ingested, consult a physician or poison control center immediately.
- Do not attempt to disassemble the toner cartridge. The toner may scatter and get into your eyes or mouth. If toner gets into your eyes or mouth, wash them immediately with cold water and immediately consult a physician.
- If toner spills from the toner cartridge, avoid inhaling it or allowing it to come into contact with your skin. If the toner comes into contact with your skin, wash immediately with soap and cold water. If you inhale the toner or your skin becomes irritated due to contact with the toner, consult a physician or poison control center immediately.

Others

WARNING

- If you are using a cardiac pacemaker:
This machine generates a low level magnetic field. If you feel any abnormalities in your body while using this machine, please move away from the machine and consult your physician immediately.

Legal Notices

Legal Limitations on the Usage of Your Product and the Use of Images

Using your product to scan, print or otherwise reproduce certain documents, and the use of such images as scanned, printed or otherwise reproduced by your product, may be prohibited by law and may result in criminal and/or civil liability.

A non-exhaustive list of these documents is set forth below. This list is intended to be a guide only. If you are uncertain about the legality of using your product to scan, print or otherwise reproduce any particular document, and/or of the use of the images scanned, printed or otherwise reproduced, you should consult in advance with your legal advisor for guidance.

- Paper Money
- Money Orders
- Certificates of Deposit
- Postage Stamps (canceled or uncanceled)
- Identifying Badges or Insignias
- Selective Service or Draft Papers
- Checks or Drafts Issued by Governmental Agencies
- Motor Vehicle Licenses and Certificates of Title
- Travelers Checks
- Food Stamps
- Passports
- Immigration Papers
- Internal Revenue Stamps (canceled or uncanceled)
- Bonds or Other Certificates of Indebtedness
- Stock Certificates
- Copyrighted Works/Works of Art without Permission of Copyright Owner

FCC (Federal Communications Commission)

imageCLASS D560: F165400

imageCLASS D530: F165400

This device complies with Part 15 of the FCC Rules. Operation is subject to the following two conditions:

1. This device may not cause harmful interference, and
2. This device must accept any interference received, including interference that may cause undesired operation.

FCC WARNING

Changes or modifications not expressly approved by the party responsible for compliance could void the user's authority to operate the equipment.

NOTE

This equipment has been tested and found to comply with the limits for a class B digital device, pursuant to Part 15 of the FCC Rules. These limits are designed to provide reasonable protection against harmful interference in a residential installation. This equipment generates, uses and can radiate radio frequency energy and, if not installed and used in accordance with the instructions, may cause harmful interference to radio communications. However, there is no guarantee that interference will not occur in a particular installation. If this equipment does cause harmful interference to radio or television reception, which can be determined by turning the equipment off and on, the user is encouraged to try to correct the interference by one or more of the following measures:

- Reorient or relocate the receiving antenna.
- Increase the separation between the equipment and receiver.
- Connect the equipment to an outlet on a circuit different from that to which the receiver is connected.
- Consult the dealer or an experienced radio/TV technician for help.

Use of shielded cable is required to comply with class B limits in Subpart B of Part 15 of the FCC Rules. Do not make any changes or modifications to the equipment unless otherwise specified in this manual. If you make such changes or modifications, you could be required to stop operation of the equipment.

Canon U.S.A., Inc.

One Canon Park, Melville, NY 11747, U.S.A.

TEL No. 1-800-OK-CANON

Laser Safety

This machine complies with 21 CFR Chapter 1 Subchapter J as a Class 1 laser product under the U.S. Department of Health and Human Services (DHHS) Radiation Performance Standard according to the Radiation Control for Health and Safety Act of 1968. This means that the machine does not produce hazardous radiation.

Since radiation emitted inside the machine is completely confined within protective housings and external covers, the laser beam cannot escape from the machine during any phase of user operation.

CDRH Regulations

The Center for Devices and Radiological Health (CDRH) of the U.S. Food and Drug Administration implemented regulations for laser products on August 2, 1976. These regulations apply to laser products manufactured from August 1, 1976. Compliance is mandatory for products marketed in the United States.



CAUTION

Use of controls, adjustments, or performance of procedures other than those specified in this manual may result in hazardous radiation exposure.

The label is attached to the laser scanner machine inside the machine and is not in a user access area.



Memo

Canon

CANON INC.

30-2, Shimomaruko 3-chome, Ohta-ku, Tokyo 146-8501, Japan

CANON MARKETING JAPAN INC.

16-6, Konan 2-chome, Minato-ku, Tokyo 108-8011, Japan

CANON U.S.A., INC.

One Canon Park, Melville, NY 11747, U.S.A.

CANON EUROPA N.V.

Bovenkerkerweg 59, 1185 XB Amstelveen, The Netherlands

CANON CHINA CO. LTD.

15F Jinbao Building No.89, Jinbao Street, Dongcheng District, Beijing 100005, PRC

CANON SINGAPORE PTE LTD

1 HarbourFront Avenue, #04-01 Keppel Bay Tower, Singapore 098632

CANON AUSTRALIA PTY LTD

1 Thomas Holt Drive, North Ryde, Sydney NSW 2113, Australia

CANON GLOBAL WORLDWIDE SITES

<http://www.canon.com/>

Serial No.	
Date of Purchase	

